



Army

Preparing the Australian Army for Joint Employment

**A Short History of the Adaptive
Army Initiative 2007–2010**

Bob Breen

© Commonwealth of Australia 2014

This work is copyright. Apart from any fair dealing for the purpose of study, research, criticism or review (as permitted under the Copyright Act 1968), and with standard source credit included, no part may be reproduced by any process without written permission.

Inquiries should be directed to:

Directorate of Future Land Warfare
Army Headquarters
Russell Defence Offices
PO Box 7901
Canberra BC ACT 2610

Email: dfw.publications@defence.gov.au

Web: www.army.gov.au/Our-future/Publications

**National Library of Australia
Cataloguing-In-Publication Entry**

Author: Breen, Bob

Title: Preparing the Australian Army for Joint Employment: A Short History of the Adaptive Army Initiative 2007-2010 / Bob Breen

ISBN: 978-0-9874959-1-4

Other Authors/Contributors: The Australian Army, issuing body.

Preface

Australia's armed forces should be proud of their regional and international operations over the past 20 years. The ADF has met the expectations of governments and justifiably earned – and continues to enjoy – widespread public support and admiration. However there is room for improvement in preparing, commanding, deploying, employing and sustaining land forces overseas – the complex business of land force projection.

My contention is that, without the competence to project land forces nationally, regionally and internationally, preferably in the company of powerful allies and regional partners, Australians will be fated to defend their homeland on home soil without the ability to militarily safeguard national interests in their regional neighbourhood or further afield. My PhD thesis and published accounts of Australian stabilisation and peacekeeping operations in Somalia, Bougainville and East Timor identify the reasons such improvements should be made.

In 2007 a number of events and ideas combined to initiate improvements to land force projection. By 2008 I recognised that the Adaptive Army initiative was one of the most significant structural reforms since the Hassett Review recommended the establishment of the Army's functional command system in the early 1970s. I was impressed to discover that the Army was not only strengthening its capability and capacity to generate land forces for the defence of the Australian homeland, but was also streamlining the challenging process of preparing and projecting land forces, often at short notice, for joint employment overseas – the same processes that would be needed to defend the vast Australian continent and its offshore territories.

In 2009 and 2010 I was granted access to those involved in reorganising the Army and also to key documents. While I followed the reorganisation of Army Headquarters with interest, I focused my research on the formation of Forces Command and the new role of Headquarters 1st Division.

This monograph is a history of record and an analysis of the contribution of the Adaptive Army initiative to the self-reliant military force projection that underpins Australia's sovereignty – the ADF's main game.

The views expressed in this monograph are mine and do not represent the views of the Department of Defence and the ADF, in general, or the Army and its senior leadership group in particular.

Bob Breen

Canberra 2014

Acknowledgements

I am grateful to Lieutenant General David Morrison, the current Chief of Army, then Commander of the newly formed Forces Command, who authorised access to departmental files and encouraged the production of this short history. Colonel John Shanahan assisted me with access and was an erudite sounding board, not simply a point of contact. John transferred from the British Army in 2008 bringing with him a wealth of experience, competence and enthusiasm. He was also someone who could compare and contrast the British and Australian ways of doing military business.

Major generals Paul Symon and Mick Slater, brigadiers (now Major General) Shane Caughy, Mick Moon, (now Major General) Jeff Sengelman, and (now Major General) Simone Wilkie, Colonel Mike Tucker and Lieutenant Colonel (now Brigadier) Mick Ryan were generous with their time and offered research material, as well as their own personal views.

For the production of the monograph, I am grateful once again for the editorial ministrations of Cathy McCullagh and Denny Neave of Big Sky Publishing for producing a high-quality publication.

Contents

Preface	ii
Acknowledgements	iv
Tables and Diagrams	vi
Acronyms and Abbreviations	viii
Glossary	x
Chronology	xiii
Introduction	1
Land Force Projection	4
Genesis	13
Articulating and Directing Change	33
Getting Training Right – Generic Force Preparation	37
Preparing to Fight – Specific Force Preparation	54
Preparing to Deploy and Establishing Supply	63
Implementing Change	69
The Culmination of the Beginning: Exercise Hamel 2010	80
Audit of the Adaptive Army Initiative: Improvements and Challenges	89
Bibliography	97
Index	100
About the Author	108

Tables and Diagrams

Figure 1. Functions of force projection

Figure 2. Model 1 – operations workshop

Figure 3. Model 1 – options for Forces Command

Figure 4. Model 2 – operations workshop

Figure 5. Workshop 2 – Model 1

Figure 6. Workshop 2 – Model 2

Figure 7. Workshop 3 – Model 1

Figure 8. Workshop 3 – Model 2

Figure 9. Tasks for Forces Command

Figure 10. Outline organisation of HQ FORCOMD – November 2008

Figure 11. Detailed organisation of HQ FORCOMD – November 2008

Figure 12. Levels of training in the Army Training Continuum

Figure 13. Training standards in the Army Training Continuum

Figure 14. The learning loops

Figure 15. Division of responsibilities Forces Command and HQ 1st Division – August 2008

Figure 16. Development tasks for specific force preparation 2008

Figure 17. Organisational responsibilities for specific force preparation

Figure 18. Force generation 2008–2010

Figure 19. DCU tasking relationships – 2008

Figure 20. ADF organisational 'muscle groups' for force projection

Acronyms and Abbreviations

1 GL Gp	1 Ground Liaison Group
1 Int Bn	1 Intelligence Battalion
1 JMOVGP	1 Joint Movements Group
2/30 Trg Gp	2/30 Training Group
6 ESR	6 Engineer Support Regiment
7 Sig Regt	7 Signals Regiment
16 AD Regt	16 Air Defence Regiment
16 Avn Bde	16 Aviation Brigade
17 CSS Bde	17 Combat Service Support Brigade
19 CE Works	19 Chief Engineer Works
20 STA	20 Surveillance and Target Acquisition
39 PSB	39 Personnel Support Battalion
51 FNQR	51 Far North Queensland Regiment
ACLP	Army's Continuing Learning Process
ADF	Australian Defence Force
AHQ	Army Headquarters
ANAO	Australian National Audit Office
APS	Australian Public Service
ARH	Armed Reconnaissance Helicopter
ASJET	Australian Joint Essential Tasks
ASPI	Australian Strategic Policy Institute
ATC	Army Training Continuum
AWT	adaptive warfare teams
CA	Chief of Army
CAG	Commander's Advisory Group
CAPD	Chief of Army's Preparedness Directive
CASAG	Chief of Army Senior Advisory Committee
CATA	Combined Arms Training Activity
CBRN	chemical, biological, radiological and nuclear
CDE	Capability Development Executive
CDF	Chief of the Defence Force
CDSS	Centre for Defence and Strategic Studies
CIMIC	civil-military cooperation
CJLOG	Commander, Joint Logistics
CJOPS	Chief of Joint Operations
CJTF	Combined Joint Task Force
COE	contemporary operating environment

COMD FORCOMD	Commander Forces Command
COMDT RMC	Commandant Royal Military College
CS&ISTAR	combat support and intelligence, surveillance, target acquisition and reconnaissance
CTC	Combat Training Centre
DCA	Deputy Chief of Army
DCU	direct command units
DCSTC	Defence Command Support Training Centre
DFAT	Department of Foreign Affairs and Trade
DFSL	Defence Force School of Languages
DFSM	Defence Force School of Music
DFSS	Defence Force School of Signals
DGPP-A	Director General Preparedness and Plans – Army
DGT	Director General of Training
DIGO	Defence Imagery and Geospatial Organisation
DIntTC	Defence Intelligence Training Centre
DIO	Defence Intelligence Organisation
DMETL	directed mission essential task list
DMO	Defence Materiel Organisation
DPTC	Defence Police Training Centre
DSG	Defence Support Group
DSTO	Defence Science and Technology Organisation
EW	electronic warfare
G3	Operations Branch
G7	Training and Education Branch
GOC LOGCOMD	General Officer Commanding Logistic Command
HCD-A	Head Capability Development – Army
HOTO	handover/takeover
HQ AST	HQ Australian Theatre
HQ JLC	Headquarters Joint Logistic Command
HQ JOC	Headquarters Joint Operations Command
IE	international engagement
IET	Initial Employment Training
IED	improvised explosive devices
IO	information operations
ISTAR	intelligence, surveillance, target acquisition and reconnaissance
JDSSC	Joint Decision Support Simulation Centre
JLU	Joint logistic units
JTF	joint task force
LCOT	land combat operational tasks

LCRC	Land Combat Readiness Centre
LHQ	Land Headquarters
MEF	Modularised Engineer Force
METL	mission essential task list
MRE	mission rehearsal exercise
MST	mission-specific training
NGO	non-government organisation
NORFORCE	North-West Mobile Force
ODF	Operational Deployment Force
OTG	Observer Trainer Group
OVP	operational viability period
PDTF	Pre-Deployment Training Fleet
Pilbara Regt	Pilbara Regiment
PR	Public Relations
PSYOPS	psychological operations
RDD	Radiological Dispersion Device
RFSU	Regional Force Surveillance Units
RMC-A	Royal Military College of Australia
ROE	Rules of Engagement
RSO&I	reception, staging, onward movement and integration
SO1	Staff Officer Grade 1
SOP	Standard Operating Procedures
SOCOMD	Special Operations Command
TARP	Training and Resources Plan
TRADOC (US)	Training and Doctrine Command
TTP	tactics, techniques and procedures
UAV	unmanned aerial vehicle
VCDF	Vice Chief of the Defence Force

Glossary

Ab Initio training: initial basic military training.

Administrative control: the direction or exercise of authority over subordinate or other organisations for administrative matters such as personnel management, supply services and other matters not included in the operational missions of the subordinate or other organisations.

Army Training Continuum: commences with *Ab Initio* training and progresses through individual and collective training and force preparation to produce force elements for joint employment. Training encompasses a combination of tasks conducted to a standard, level, condition and frequency.

'A war': a generic conflict within a general threat environment in which land forces are able to conduct sustained operations against a recognisable enemy for a general purpose. Preparation for 'a war' is based on Foundation Warfighting training and is focused on force generation for future missions in which force elements are able to conduct the full spectrum of operations.

Collective training: the training of one or more crews or detachments, sub-units, units and formations in the conduct of tactical operations.

Force preparation: the planning and execution of collective and joint training that takes a force element from the assignment start state to a level of preparation for deployment or contingencies specified by CA and CJOPS. Force preparation builds on the core foundation warfighting skills to produce force elements for specific operational and contingency circumstances. It has five components:

- force concentration
- mission-specific training (MST) (individual and collective)
- equipment (specific to mission)
- mission rehearsal exercises (MRE)/contingency rehearsals
- assessment and certification

Foundation Warfighting training: the fundamental individual and essential core collective training that underpins operational capability and readiness to enable force elements to successfully conduct the full spectrum of sustained operations required for adaptive campaigning.

Force generation: the process of organising, training and equipping forces for adaptive campaigning. Force generation has five major components:

- training, education and development of individual members of the force and the generation of a core collective training capability at prescribed levels and standards
- force structure (numbers of people and composition of the force)
- equipment (technology, weapon systems and quantity of equipment)
- readiness (the ability to provide capabilities to execute an assigned mission)
- sustainability (the ability to maintain the assigned level of operational activity for a specified duration)

High readiness forces: forces identified for specific contingencies that have been trained to the highest appropriate warfighting foundation training levels, short of conducting MST and MRE.

Individual training: the training, education and development that equip individuals with the skills, knowledge and attitudes to enable them to take their place in a team.

Mission-specific training: mission-specific training is built on Foundation Warfighting training and is the training for directed tasks that delivers the particular knowledge, skills and attitudes to prepare the individual, team or task force to deploy on operations in a specific theatre, role or environment. The content of mission-specific training is driven by the mission, environment and threat.

Reconstitution: the re-integration of force elements within their parent formations and their remediation to the level of capability required to undertake assigned roles and missions.

Start state: the agreed levels and standards of a force element at the agreed point when those forces transfer from the command of one organisation to another. Reporting includes information on personnel, equipment, and training issues and respective responsibilities for resolution. The start state comprises:

- training level and standard
- force structure
- manning
- equipment
- readiness
- sustainability

Surge: the term 'surge' is used in this publication to describe the requirement for a short-notice increase in goods and services to prepare a land force to deploy overseas. The goods required range from clothing, equipment, arms and ammunition for individuals to major items of equipment, technology, vehicles and weapon systems for deploying units. Services can include additional accommodation, catering, medical and administrative support, training areas and firing ranges, as well as upgrading/servicing the fleets of vehicles, equipment and weapons already issued to deploying units. Often surges require additional personnel from other units or contractors to be assigned at short notice to provide this surge of goods and services while those deploying prepare themselves.

Technical control: the specialised or professional guidance and direction exercised by an authority in technical (professional) matters. Technical control is not a command or operational authority, but may be used where necessary to designate the specialised and professional operating procedures essential to the proper management and operation of forces. In an operational setting, technical control generally constitutes advice of a single service nature on technical operation and maintenance matters. Technical control is normally a responsibility retained within each single service and is usually not delegated. However, in joint operations, a division of responsibility for technical maintenance may be specified in directives assigning forces and assets. Technical control advice may not be modified, but may be rejected in part or in total by a commander in consideration of operational factors (*ADF Joint Operational Command and Control, Canberra, 2001*)

The agreed point: the place, time or event where formal control of the force elements passes from one organisation to another. This applies to the transfer of command from FORCOMD to HQ 1st Division for the commencement of specified force preparation, and to the point at which formal control of land force elements passes from HQ 1st Division back to FORCOMD. It applies also to the transfer of land forces to and from HQ 1st Division and HQ JOC.

'The war': the specific conflict within a specified threat environment in which land forces are currently deployed or about to deploy with a known or specific mission. Preparation for 'the war' is optimised by the use of mission-specific training and mission rehearsal exercises, which build on Foundation Warfighting training and are focused on force preparation for specific missions and contingencies.

'The next war': the anticipated operational environments in which land forces will fight or coerce hostile forces with a range of capabilities and attributes. Preparation for 'the next war' is based on both short-term readiness for specified contingencies and longer term development of capabilities for future operations based on analysis of technological and doctrinal developments and the intentions of states and non-state organisations.

Chronology

2007

Establishment reviews, reports from the Combat Training Centre and Centre for Army Lessons on operational performance and finalisation of joint ADF command and control arrangements with the opening of HQ Joint Operations Command create imperatives for changing the Army's structure.

2008

- February Major Generals Gillespie and Morrison conceive what would become the Adaptive Army initiative in conjunction with Brigadier Paul Symon and Future Land Warfare staff.
- Brigadier Paul Symon establishes 4D staff group and begins developing models and change management strategies and planning a program of consultative workshops.
- 12-13 May Workshop 1– Operations, JDSSC, Fairbairn.
- 27 May Workshop 1 back brief to CA.
- 6 June Workshop 2 – Personnel Management and Logistics, JDSSC, Fairbairn.
- 27 June Workshop 3 – Resource Management and Governance, JDSSC, Fairbairn.
- 4 July Lieutenant General Gillespie assumes command of the Army.
- 7 July Red Team Review, RMC-A.
- 8 July Lieutenant General Gillespie issues Order of the Day on assumption of command of the Army.
- 17 July Generals' Day, RMC-A.
- 4 August Lieutenant General Gillespie submits ministerial submission, 'The Adaptive Army Initiative', and paper, 'Adaptive Army: an Evolved Army Functional Command Structure'.
- 27 August Lieutenant General Gillespie announces the Adaptive Army initiative at an ASPI Conference and issues Directive 22/08 'Adaptive Army: The Evolution of Army's Higher Command and Control Structures'.
- August Major General Ash Power, Commander Training Command, and his staff begin exploring options for amalgamating Land Headquarters (LHQ) and HQ Training Command, in conjunction with Major General Mark Kelly, the Land Commander, and his staff.

- 29 September Major General Wilson presents his concept for specific force preparation to his staff at HQ 1st Division.
- 3 December Lieutenant General Gillespie assumes direct command of HQ 1st Division from Land Command. LHQ begins handing over operational planning responsibilities with HQ Joint Operations Command (JOC) to HQ 1st Division, and transferring the management of minor operations and prescribed activities to HQ JOC.
- Major General Mick Slater, COMD 1st Division, becomes responsible for and accountable to Lieutenant General Gillespie for specific force preparation, including concentration, mission-specific training (MST), mission rehearsal exercises (MRE) and certification, as well as reception, sustainment, onward movement and integration (RSO&I) for land forces, ad hoc contingents and individuals redeploying from operations as part of the rotation cycle.

2009

- Mid-February Brigadiers Shane Caughy and Simone Wilkie 'war game' recommended structure of HQ FORCOMD.
- From mid-April Staff move, branch by branch and function by function, one after the other, to their new office spaces at Victoria Barracks, Sydney.
- 1 July Major General David Morrison and newly restructured HQ FORCOMD assume command of 85% of the Army and its generic force preparation on behalf of Lieutenant General Ken Gillespie, Chief of Army.
- Major General Mick Slater and newly enhanced HQ 1st Division assume responsibility for specific force preparation of land forces assigned for joint employment.
- Brigadier Jeff Sengelman assumes command of what would become the 6th Brigade (about 3000 personnel, serving in 11 units dispersed in 38 locations around Australia).
- November Planning and preparation for Exercise Hamel begins under direction of Brigadier John Frewen.

2010

- October Exercise Hamel.
- 2–9 October HQ FORCOMD staff under Colonel James Burns establish Exercise Control at Lavarack Barracks, Townsville.
- Deployable elements from 17 CSS Brigade under Colonel Jim Evans establish a mounting base there and a forward operating base at Macrossan, inland from Townsville.
- 10–13 October After concentrating in Townsville, exercise forces deploy to the area of operations by road, sea and air via the forward operating base at Macrossan.

- 14–28
October
- The 3rd Brigade group (two battlegroups) secures its area of operations and conducts joint land combat at brigade level as well as stabilisation operations.
- The Ready Battle Group and Air Combat Team conduct an emergency evacuation operation and support the local population with humanitarian assistance in the Innisfail and Tully area in Far North Queensland. As part of the deployment, 3 RAR conducts a parachute jump at Charters Towers, the Airborne Combat Team Certification jump.
- 29 October–5
November
- The 3rd Brigade Group prepares for and conducts live firing exercise in a combined arms offensive operations setting.

Introduction

In 2011 Professor Hugh White, a respected and erudite contributor to the public debate on Australia's strategic priorities and defence policies, postulated that 'the army of an island nation will always be either a purely defensive force or an expeditionary one'¹. Australia, the world's largest island nation, has a tradition of employing land forces in the latter role. With the exception of a 15-year period following the end of Australia's participation in the Vietnam War in 1972, the Army's commissions from the nation have been expeditionary.² Even before the advent of nationhood, military expeditions were launched to the Sudan (1885) and continued periodically thereafter around the globe until an interregnum from 1973 until 1986. Since 1986, Australian forces have participated in post-Cold War stabilisation, peacekeeping and humanitarian operations overseas, including in Africa (Namibia, Somalia and Rwanda), the Middle East (Israel, Iraq, Pakistan and Afghanistan), South-East Asia (Cambodia, Indonesia and Timor Leste) and the South Pacific (Bougainville, Solomon Islands and Tonga). Smaller contingents have also served overseas on peacekeeping operations.

Sir Julian Stafford Corbett, renowned British naval historian and geo-strategist, suggests that the army of an island nation does not have to confine itself to either a purely defensive or an expeditionary posture:

By maritime strategy we mean the principles which govern a war in which the sea is a substantial factor. Naval strategy is that part of it which determines the movements of the fleet and maritime strategy has determined what role the fleet must play in relation to the action of land forces; for it scarcely needs saying that it is almost impossible that war can be decided by naval action ...

Since men live upon the land and not upon the sea, great issues between nations at war have always been decided – except in the rarest cases – either by what your army can do against your enemy's territory and national life or else by the fear of what the fleet makes it possible for your army to do. The paramount concern, then, of maritime strategy is to determine the mutual relations of your army and navy in

1 Hugh White, 'The Future of the Australian Army', *Security Challenges*, Vol. 7, No. 2 (winter 2011), p. 27.

2 Expeditionary force: an armed force organised to accomplish a specific objective in a foreign country (US Department of Defense, *Dictionary of Military Terms*, 2009); forces projected from the home base capable of sustained operations at a distance from that home base (Ministry of Defence, *United Kingdom Glossary of Joint and Multinational Terms and Definitions*, JWP 1-01.1, 2009).

*a plan of war. When this is done, and not till then, naval strategy can begin to work out the manner in which the fleet can best discharge the function assigned to it.*³

Corbett wrote before the advent of air power which, arguably, significantly enhances the advantages of a maritime strategy for the defence of Australia and its interests. Indeed, Australia began applying a maritime strategy with the deployment of the Australian Naval and Military Expeditionary Force in 1914, and continued to do so with the significant contribution of US and Australian air power during the Pacific War from 1941 to 1945.

Currently, following almost two decades of continuous regional and international operations, the Army has no significant forces deployed overseas. The temptation is to pare the force back. Why not return to the 1980s? All Australia needed then and now is a specialised light infantry brigade in Townsville ready to quickly deploy overseas for near-region contingencies and Special Forces for counter-terrorism. The remainder of the Army could bolster continental defences and contribute occasionally to national disaster relief when state and territory authorities are overwhelmed.

In 2011 White appeared to favour this continental role for the bulk of the Army, questioning its viability as an expeditionary force.⁴ He expressed concern about the future of the Army in 'defending Australia's wider strategic interests against conventional military threats in a more contested Asia', concluding that the Army would neither satisfy the nation's requirements to support the United States in a military contest in Asia or defend Australia from an Asian adversary. Moreover, White deemed 'expeditionary land operations of any kind' as 'most unlikely to provide viable strategic options for Australia'.⁵ He doubted that Australia's 'very small army' with its 'very limited amphibious capability' could make any difference beyond Australian shores. In his opinion, the only role it might play in the future would be to maintain sufficient strength as a defensive force based in Australia to oblige a predatory Asian power to deploy a larger invasion force that would 'offer a valuable and vulnerable target to Australia's air and sea denial forces'.⁶

In contrast to White's 2011 strategic assessment of the futility of an Army organised and trained for force projection, the Chiefs of Army began reorganising the Army in anticipation of the 2009 Defence White Paper which would confirm the Army's role in a maritime strategy.

At the end of 2011, one of the Army's reorganisers, the newly appointed Chief of Army Lieutenant General David Morrison, announced Plan Beersheba, the reorganisation of the Army into three multi-role manoeuvre brigades, each supported by two Reserve brigades. Subsequently, a battalion group joined the Australian Amphibious Task Group, which was to begin operating two Landing Helicopter Docks in 2015. The purchase of these amphibious ships and a number of Air Warfare Destroyers underpins Australia's maritime strategy which also includes the employment of Joint Strike Fighters.

Professor Hugh White and Sir Julian Stafford Corbett represent two schools of thought on the roles of the armies of island nations. Common to these schools is the requirement to project land forces for joint employment whether the area of operations is within Australian borders and territorial waters, in the near region or further afield.

3 Sir Julian Stafford Corbett, 'The Theory of War' in *Some Principles of Maritime Strategy*, Classics of Seapower series, Naval Institute Press, Annapolis, 1988; Albert Palazzo, 'Maritime Strategy and the Operations of the Australian Army' in Palazzo, Trentini, Hawkins and Brailey, *Projecting Force: The Australian Army and Maritime Strategy*, Land Warfare Studies Centre, Canberra, 2010.

4 White, 'The Future of the Australian Army', p. 27; Hugh White, *Beyond the Defence of Australia: Finding a New Balance for Australia's Defence Policy*, Lowy Institute for International Policy, Sydney, 2006; Hugh White, 'Four Decades of the Defence of Australia: Reflections on Australian Defence Policy over the past 40 Years' in Huisken and Thatcher (eds), *History as Policy: Framing the Debate on the Future of Australia's Defence Policy*, ANU ePress, Canberra, 2007.

5 *Ibid.*, p. 30.

6 *Ibid.*, p. 31.

In the last years of the first decade of the twenty-first century Lieutenant General Morrison and his predecessors, Lieutenant Generals Ken Gillespie and Peter Leahy, decided to reorganise and rebuild the Army after almost two decades of expeditionary operations. The Adaptive Army initiative and its predecessor, the Hardened and Networked Army, were about preparing land forces for joint employment. Why did they do this and how did the reorganisation measure up? This is the central question posed – and answered – in this monograph.

Land Force Projection

It is a fundamental national obligation to defend sovereign territory. For an island nation such as Australia, this includes defending maritime and air approaches to the homeland. Investment in strong maritime and air forces is crucial. Australian ships and aircraft could destroy enemy ships and aircraft far from the mainland, obviating the necessity to fight 'on the beaches', so to speak. Investment in land forces is just as crucial. Australia has historically deployed land forces offshore periodically for a number of reasons, including to support the interests of the British Empire in the late 1880s and 90s; to support allies in the First World War (1914–18) and the Second World War (1939–45), including defence of the homeland in the early 1940s; to assist allies in the defence of the North Asia, Middle East and South-East Asian regions in the 1950s and 1970s; to support peace in East Timor and the South Pacific; and to participate in UN and UN-endorsed post-Cold War peacekeeping and peace enforcement operations in the 1990s and 2000s. Land forces have also become important for counter-terrorism and hostage recovery, border protection, and disaster relief and evacuation operations.

Alliance obligations have been – and will continue to be – the main reasons for decisions to project Australian land forces overseas. Projections to the Middle East in the 1990s and 2000s are examples of the fulfillment of alliance obligations. During the past 20 years, force projections have also occurred in response to instability in Australia's near region. Regional neighbours have increasingly relied on Australia to deploy land forces in response to emergencies caused by political and ethnic conflicts, as well as natural disasters.

Australian governments also project land forces in response to international events. The Army has not remained in its barracks while its allies and the United Nations faced military and humanitarian emergencies alone. The Australian people and their governments invariably choose regional and international military force projection over continental defence and isolationism, although the purpose, strength and duration of overseas operations and campaigns are often the subject of public debate and differing opinions.

In 2009 and 2013 the Australian government made the preparation and projection of land forces for joint operations in a maritime strategy mandatory.⁷ Extracts from government policy papers illustrate Australia's contemporary strategic priorities:

⁷ Department of Defence, *Defending Australia in the Asia Pacific Century: Force 2030*, Australian government, Canberra, 2009; Department of Defence, 2013 Defence White Paper, Australian government, Canberra, 2013.

- The principal task of the ADF is to deter and defeat armed attacks on Australia by conducting independent military operations without relying on the combat or combat support forces of other countries (*Force 2030 7.2 and DWP 13 3.35*).
- Australia's defence policy is founded on the principle of self-reliance in deterring or defeating armed attack on Australia, within the context of our alliance with the United States and our cooperation with regional partners (*DWP 3.36 and 3.42*).
- After ensuring the defence of Australia from direct attack, the second priority task of the ADF is to contribute to stability and security in the South Pacific and East Timor. This involves conducting military operations, in coalition with others as required, including in relation to protecting our nationals, providing disaster relief and humanitarian assistance, and on occasion by way of stabilisation interventions as occurred in East Timor in 1999 and 2006, and in Solomon Islands in 2003 (*Force 2030 7.10 and DWP 3.49*).
- Given our size and resources, Australia will be expected to take a leadership role in the South Pacific if these states are overwhelmed by natural or man-made crisis (*Force 2030 7.11 and DWP 3.52-53*).
- The next most important priority task for the ADF is to contribute to military contingencies in the Asia-Pacific region, including in relation to assisting South-East Asian partners to meet external challenges, and to meeting our alliance obligations to the United States (*Force 2030 7.13 and DWP 3.56*).
- Finally, the ADF has to be prepared to contribute to military contingencies in the rest of the world, in support of efforts by the international community to preserve global security and a rules-based international order, where our interests align and where we have the capacity to do so (*Force 2030 7.19 and DWP 3.58-60*). These priorities mandate the projection of land forces nationally, regionally and internationally to satisfy the imperatives of the 2009 and 2013 Defence White Papers. They are unlikely to change significantly in the foreseeable future:
- National force projection protects sovereign Australian territory from direct attack by armed forces. The premise is that the Australian people expect the ADF to control the air and sea around the island continent, and prevent landings by armed forces or any groups inimical to Australia's national interests.
- Regional force projection helps to secure Australia's near region, with emphasis on the approaches to Australia's north and east coasts. The premise is that Australia has a direct strategic interest in the security and stability of its immediate neighbourhood which it shares with New Zealand, Indonesia, Papua New Guinea, Timor Leste and the South Pacific island states.
- International force projection is Australia's contribution to the stability of the wider Indo-Pacific region which stretches from North Asia to the eastern Indian Ocean, and to international cooperation that prevents aggression by states against one another.

Functions of Force Projection

The Australian military publication *Joint Warfighting* describes 'operational level functions' within a Joint Warfighting Framework that include all the mechanics of force projection.⁸

There is nothing new about these functions (see Figure 1). They are as old as the formation of nation states; in rudimentary form, they predate them. From the earliest times when humans gathered in collective defence of their territory or to make new conquests, they executed all or some functions with varying degrees of capacity, proficiency and sophistication. Some clarification and definition is necessary before continuing this discussion.

8 Australian Defence Force, *Joint Warfighting*, Australian Defence Force Doctrine Publication ADDP-D-4, Defence Publishing Service, Canberra, 2004, pp. 2-15–2-16, Annex A to Chapter 2.

Figure 1 Functions of Force Projection

Function	Elements
Generic Preparation	Military capability that is made up of force structure, readiness, mobilisation and sustainability
Command	Command, control, communications and computer systems
Specific Preparation	Concentration of force elements in mounting or home bases, reconnaissance, reinforcement, training, administration and issue of equipment and stocks
Deployment	Concentration of personnel and matériel, loading, movement of force elements to area of operations and, best effect arrival and pre-positioning
Protection	Intelligence, surveillance, contingency rehearsal and rapid response
Employment	Conduct of operations that may include maintaining deterrent presence, manoeuvre and application of firepower
Sustainment	Planning and carrying out the movement of supplies and maintenance of forces through a supply chain
Rotation	Reinforcement, relief, resting, retraining, re-equipping and redeployment of force elements
Redeployment	Protected movement to specified locations, normally home bases
Reconstitution	Return to required level of military capability

Force projection begins with four functions that culminate in deployment. Most nation states maintain pre-positioned extant military capability (generic force preparation) under some form of command and control (force command). Periodically, they mobilise extant and latent military capabilities and then prepare maritime, land and, in modern times, air force and Special Forces elements (specific force preparation) to take specified military action. They then move forces to advantageous locations and circumstances, ideally after thorough reconnaissance, to begin (force deployment). Deployment includes reception, staging, onward movement and integration (RSO&I). Typically, nations prefer to deploy forces beyond their borders so that their populations remain safe and their homelands are not laid waste. Following deployment, commanders employ force elements (force employment) under designated command arrangements that are extensions of command in the homeland while ensuring their protection (force protection) and sustainment (force sustainment). During longer operations and campaigns, commanders reinforce, relieve, rest, retrain, re-equip and redeploy force elements (force rotation).

Final functions return forces to generic preparedness. With the end of operations and campaigns, forces redeploy (force redeployment) inside borders or to locations beyond borders. They reconstitute (force reconstitution), either with more capability or less, depending on the perceived level of remaining threat or, more generally, on national will to maintain military capabilities for ongoing defence. Reconstitution completes the cycle of force projection back to generic preparedness.

Force Projection Proficiency

Proficiency in all ten functions demonstrates Australian military capability and intent, measures national military competence and has to meet government and public expectations. But what does 'proficiency' actually mean? Proficiency is the capability and capacity for prompt, strong and smart military action that satisfies the Australian government's expectations. It begins with maintaining generic military capability – force structure, modernisation, readiness and

sustainability. There should be sufficient warning for the assignment of forces, as well as their specific force preparation.

Preparations should be resourced, coordinated and informed by inputs, such as reconnaissance, intelligence and cultural and political information concerning the area of operations. These preparations, including the assembly and loading of personnel and materiel, should be followed by protected deployment by sea and air that enables forces to arrive with best effect – on time, fresh, well rehearsed and ready for employment.

Command and sustainment arrangements should facilitate effective, efficient, intelligent and safe employment of forces to achieve the desired results. These arrangements should maintain the required tempo of operations. Following the conclusion of operations and campaigns, forces should redeploy safely and reconstitute efficiently.

It is important to measure proficiency under pressure of time. Since the end of the Cold War in 1989, governments have tended to direct the ADF to project joint forces with fewer than four weeks' notice, or to constrain military planning while considering options for responding to overseas events that may require military intervention. As the time to prepare diminishes, risks increase commensurately. Accordingly, the ADF must have well-rehearsed organisational 'muscle groups' that can generate, prepare and deploy forces quickly, as well as establish and prime supply chains to supply those forces efficiently.

Land Force Projection

It is more difficult for the Army to achieve proficiency in the functions of force projection than the Navy and the Air Force. For the Navy and Air Force, force projection is intrinsic. Vessels and aircraft deploy routinely into Australia's sea and air space, the northern archipelago and the South Pacific, and around the world. The roles of maritime and air force elements are generic, well defined and determined by the design and capabilities of individual vessels and aircraft, as well as their groupings. The Army has a number of more complex challenges that include:

- having forces equipped and rehearsed generically for warfighting, as well as for a range of enduring operations and other contingencies
- needing sufficient time to conduct reconnaissance and to 'top-up', train and administer assigned forces
- deploying forces safely and effectively by land, sea and air after efficient loading
- adapting to different and often politically complex and unclear requirements in climatically harsh and dangerous operational environments
- accomplishing a variety of missions shaped by a number of stakeholders, as well as overcoming or deterring adversaries
- maintaining a tempo of operations and a level of sustainment and rotation to succeed for the duration of an operation or campaign
- operating in close contact with hostile forces and groups in austere and demanding environments
- redeploying safely and reconstituting efficiently

The Navy and Air Force do not need the support of the Army except in terms of securing and protecting bases and providing some air defence. Ultimately, however, it is the Army that usually has to defeat hostile elements, either through conventional combat or as the security component of a counter-insurgency campaign. The Army typically depends on Australian or allied naval vessels and military aircraft for deployment and protection, as well as provision of the means for sustainment, manoeuvre, additional firepower and possibly redeployment. One of the major proficiency tests of Australian force projection is to synchronise maritime, land and air force elements efficiently and effectively – the benchmark of joint operations.

Problems with Land Force Projection

Australia has had plenty of practice sending land forces offshore. Australian governments, encouraged by popular opinion, deployed land forces to assist Britain during military emergencies in the Sudan (1885), southern Africa (1899–1901) and China (1900), and during the First World War (1914–18). Australian military and political responses during the Second World War (1939–45) also demonstrated that Australians would defend trade routes and their remote northern and western national territories with land forces, as well as their eastern and southern heartlands where most Australians live. Australia also has a history of deploying land forces into South-East Asia in the 1950s and 1960s to bolster alliances in order to protect the homeland – a policy known then as ‘forward defence’.

After a 15-year pause following the end of Australia’s participation in the Vietnam War in 1972, Australian governments began projecting land forces in the late 1980s (Fiji 1987, Namibia 1989) and the 1990s (Somalia 1993, Rwanda 1994, Bougainville 1994 and 1997–2003, East Timor 1999–2002). The trend has continued following the turn of the century in Iraq, Afghanistan, Solomon Islands, Timor Leste and Tonga.

Short-notice force projections to the South Pacific, Africa and the Middle East exposed a number of weaknesses in joint procedures and processes for land force projection.⁹ In addition, civilianised logistic support and garrison services struggled to surge in support of specific force preparation, deployment and sustainment of land forces, increasing the level of risk for a major deployment of land forces to East Timor in 1999.¹⁰ A number of systemic problems have persisted during the projection of land forces over the past 30 years:

- **Use of Warning Time.** The Chiefs of the Defence Force (CDF) responsible for operations did not appear to be confident that contingency planning could be kept secret outside a small group of staff officers in Canberra. Secrecy in Canberra left lower levels of command with less time to anticipate, plan and prepare.
- **Planning.** Sequential, hierarchic planning processes did not work satisfactorily or quickly enough. Concurrent planning became a matter of necessity. With hindsight, a ‘vertical’ planning compartment from Canberra to the 3rd Brigade, the Army’s high readiness formation in Townsville, would have been more useful than a ‘horizontal’ compartment in Canberra that limited planning and preparation time available to lower levels of command.
- **Reconnaissance.** Reconnaissance activities were ad hoc and rushed, and often did not include logisticians, communications specialists or engineers. Time and information were essential for logistic planning and preparation. Reconnaissance did not inform what was packed and then loaded on ships, leaving land forces short of some stocks and equipment on arrival.
- **Responsibility, Accountability, Authority and Resources for Specific Force Preparation.** There was no senior headquarters with responsibility, accountability, authority and resources to plan and conduct reconnaissance, preparatory training and administration, including pre-deployment mission rehearsals and command post exercises for offshore operations.

⁹ See Bob Breen, *Struggling for Self Reliance: Four Case Studies of Australian Regional Force Projection in the Late 1980s and the 1990s*, ANU ePress, Canberra, 2008; Bob Breen, *A Little Bit of Hope: Australian Force Somalia*, Allen & Unwin, Sydney, 1998.

¹⁰ See Bob Breen, *Mission Accomplished: The Australian Defence Force Participation in the International Forces East Timor (INTERFET)*, Allen & Unwin, Sydney, 2000, Chapters 7 and 8; Australian National Audit Office, *Audit Report No.38*, Canberra, 2000–2001.

- **Responsibility, Accountability, Authority and Resources for Mounting Base Operations.** Lead joint commanders nominated mounting authorities and mounting headquarters.¹¹ However the ADF did not have doctrine or practised procedures with other departments and agencies for delivering the goods and services required to prepare deploying forces that incorporated surges of logistic and administrative support. There was no overarching ADF machinery for synchronising joint logistic preparation or personnel administration, except through ad hoc collegial cooperation 'on the day'.
- **Responsibility, Accountability, Authority and Resources for Command.** Lead joint commanders were responsible and accountable for operational outcomes, but they did not have sufficient authority over enabling resources. Land Commanders, who were the lead joint commanders for the majority of operations, did not have authority over the ways, means (vessels and aircraft) or resources for deploying and sustaining assigned forces. The Maritime Commander controlled naval vessels and the Air Commander controlled service aircraft amid competing priorities within Australia. Logistic Command controlled stocks and fleets of vehicles and equipment, but had competing priorities and insufficient staff to support offshore operations.
- **Deployment.** The Army's logistic and movement support systems were unable to meet tight deadlines and load ships efficiently.
- **Sustainment.** There was no logistician with responsibility, authority and resources accountable to the CDF or a lead joint commander for supply chains to deployed land forces. There was no automated system for tracking demands for supply from overseas operations. The General Officer Commanding Logistic Command (GOC LOGCOMD) was the Land Commander's peer. He and his staff had other obligations within Australia to support Army activities that competed with their responsibility for supply chains to deployed forces.
- **Responsibility, Accountability, Authority and Resources for Sustainment.** While responsible and accountable for resupply to deployed land forces, GOC LOGCOMD had no authority over vessels or aircraft to move or distribute supplies. The Maritime Commander and Air Commander could only employ vessels and aircraft amid the competing priorities of the Chief of Navy (formerly Chief of the Naval Staff) and the Chief of Air Force (formerly Chief of the Air Staff) who controlled the use of these assets. In short, the root of sustainment problems lay in flaws in Army supply processes as well as problems with guaranteeing maritime and air transport effort. Supplies were not 'pushed' to land operations by commanders responsible for operational outcomes. They had to 'pull' supplies from service chiefs and their logistic commanders and from departmental managers.
- **Spare Parts.** Provision of spare parts was a major supply problem to deployed land forces. The Army's fleets of vehicles, weapons and equipment were different to those of major allies. Consequently, spare parts resupply was an Australian problem. The first challenge was to identify spare parts and move them to Moorebank, on the outskirts of Sydney, for onward movement. The second challenge was to move them overseas in a timely manner. The Army depended on the Navy and Air Force for onward movement. The supply of spare parts was unsatisfactory for all operations.
- **Applying Lessons.** All of the offshore operations in the late 1980s, the 1990s and 2000s were successful. Tactical-level post-operation reports from deployed land forces, however, described added risks, rushed preparations, unnecessary confusion and poor logistic support. There was little enthusiasm for analysing or auditing operations and applying lessons beyond distributing obligatory post-operations reports. This was a significant failing.

The two projections to Bougainville (1997–2003) and East Timor (1999–2000) constituted Exhibits A and B for changing the way the ADF prepared and projected land forces overseas. The deployment to Bougainville in 1997 was small-scale, uncontested and unarmed, but it exposed

¹¹ Headquarters responsible for reception, accommodation, training, administration of personnel and 'topping-up' — packing and loading materiel for deployment.

serious weaknesses in specific force preparation and sustainment, primarily in supply chain movements and the supply of spare parts. The larger scale armed deployment to East Timor in 1999 proved conclusively that there was significant room for improvement. The subsequent projection of a multi-agency task force to Solomon Islands in 2003 confirmed that organisational 'muscle groups' for Australian military force projection were still not aligned, synchronised or working well.¹²

Reasons for Reorganising the Army

In the late 1980s, 1990s and early 2000s, evolving ADF joint command and control arrangements and a number of overseas operations tested the Army's functional command system for preparing and projecting land forces for joint employment. For the first ten years from 1985 until 1995, the CDF took command of ADF operations and exercised it through his staff in Canberra and lead joint commanders, typically the Land Commander (after 1987) and his headquarters located at Victoria Barracks in Sydney.¹³

From 1995 until 2006, successive CDFs exercised command through a theatre commander and a new joint headquarters entitled HQ Australian Theatre (HQ AST) raised adjacent to Maritime Headquarters in Potts Point, Sydney, in 1996. The Land Commander and his headquarters became the land component of HQ AST and the Maritime Commander and Air Commander and their staffs became the maritime and air components respectively. The service chiefs were now out of the operational chain of command. They would assign forces to COMAST and HQ AST, as directed by the CDF, but only exercise administrative command of these forces during joint operations.

HQ AST included joint logistics, movements and intelligence staff groups. The CDF also assigned HQ Special Forces, which moved from Canberra to a building at the Potts Point site on Sydney Harbour. COMAST also exercised command through HQ Northern Command (NORCOM) located in Darwin, then being developed as a joint headquarters capable of commanding forces assigned to it for conducting operations across northern Australia. COMAST could also employ two deployable joint headquarters, one located at HQ 1st Division in Brisbane and the other at Potts Point in Sydney (Commander Flotillas and staff), to command joint operations.

Importantly, the service chiefs were still responsible for specific force preparation of assigned forces. The challenge for HQ AST was to rehearse assigned forces with a deployable joint force headquarters or NORCOM prior to deployment, as well as for joint employment overseas. The challenge for the Army was to prepare land forces at mounting bases in sufficient time for them to be ready for mission-specific rehearsals before deployment. Mounting bases had to possess sufficient infrastructure and 'surge capacity' to train and administer personnel and 'top-up' deploying forces with stocks.

In 1996, 'topping-up' during pre-deployment preparations and sustaining land forces after deployment fell to a new joint logistics support organisation known as Support Command that shared operational-level responsibilities with HQ AST. The Navy, Army and Air Force Support Commanders became component commanders under a new Commander Support Command in a similar way to the subordination of the Maritime, Land and Air Commanders to COMAST.

¹² See Breen, *Struggling for Self Reliance*, Chapter 13; Jim Bryant, *A More Lasting Peace: Reflections on Interagency Operations in the Solomons and Iraq*, Land Warfare Studies Centre (LWSC), Canberra, 2007.

¹³ Field Force Command was renamed Land Command in 1987.

In 1996 the CDF, General John Baker, formally began the process of establishing a new state-of-the-art headquarters building that would house a new joint strategic and operational-level headquarters. 'This plan, the most sweeping for the ADF since its inception 20 years earlier, was designed to make it a truly joint force.'¹⁴

In 2007 the CDF, Air Chief Marshal Angus Houston, began finalising ADF joint command and control arrangements with the appointment of a Chief of Joint Operations (CJOPS) and completed the transition by opening a purpose-designed HQ Joint Operations Command (HQ JOC) building at Bungendore, near Canberra, in 2009. By this time, Commander Support Command had been redesignated Commander Joint Logistics (CJLOG) and had established a strategic-level headquarters in Canberra. Simultaneously, CJLOG exercised command of business units known as joint logistic units (JLU) around Australia through a supply chain headquarters in Melbourne. The ADF was now outsourcing logistic support through commercial contractors.

In 2009, strategic guidance in the form of a Defence White Paper¹⁵ and a joint publication, Joint Operations for the 21st Century, confirmed the requirement for the self-reliant projection of land forces:

*The ADF of 2030 must be able to deploy forces responsively and rapidly, throughout our region and beyond ... In the future, the ADF will need to operate at a distance from established bases in Australia, either independently or with coalition forces. Force elements will need to be configured and prepared for short-notice deployments.*¹⁶

Progressive reviews of the structure of Army Headquarters (AHQ) and HQ 1st Division revealed the need to review the Army's internal command and control arrangements. Operational experience since 1999 also exposed weaknesses in ADF planning processes for projecting land forces that pointed to a requirement for a better interface between the Army and HQ JOC.

Those who had been involved in preparing land forces for operations over the past ten years had also endured some inefficient Army practices. The capstone doctrine *Adaptive Campaigning* prompted new thinking on preparing land forces for more complex operations that involved interacting with other government and non-government organisations (NGO), as well as populations, and also rapidly applying lessons against inventive asymmetric opponents. Changes in information technology also suggested that the Army should have fewer headquarters.

These change-drivers and the various personal approaches of the incoming Chief of Army, Lieutenant General Ken Gillespie, Deputy Chief of Army, Major General David Morrison and Brigadier Paul Symon, the Director General of Preparedness and Plans, prompted the introduction of what they would eventually title the 'Adaptive Army initiative' soon after Gillespie assumed command of the Army on 4 July 2008. These three officers possessed the breadth of contemporary command and staff experience, both overseas and in Australia, to identify what needed to be done.

The key to successful reorganisation of structures and processes lay in their ability to involve other senior Army officers and commit them to change. On 1 July 2009 General Gillespie gave the newly appointed Commander Forces Command, Major General David Morrison, responsibility for generic preparation of land forces, including the development and maintenance of what

14 David Horner, 'The Higher Command Structure for Joint ADF Operations' in Ron Huisken and Meredith Thatcher (eds), *History as Policy: Framing the Debate on the Future of Australia's Defence Policy*, Canberra Papers on Strategy and Defence No. 167, Strategic and Defence Studies Centre, ANU, 2007, p. 154.

15 Department of Defence, *Defending Australia in the Asia Pacific Century: Force 2030*, Australian government, Canberra, 2009.

16 Department of Defence, *Joint Operations for the 21st Century*, Defence Headquarters, Canberra, 2007, pp. 6; 21.

was known at the time as Foundation Warfighting capabilities.¹⁷ On the same day, Commander 1st Division, Major General Mick Slater, assumed responsibility for specific force preparation of assigned land forces for joint employment. He also became the Army's interface with HQ JOC for operational-level planning as well as technical command of deployed land forces.

The establishment of HQ JOC forced the Army to make changes to specific force preparation. The final form of HQ JOC, announced in October 2005, abolished the operational role of the maritime, land and air component commanders and their staff groups that had made the HQ AST construct unworkable. The Maritime, Land and Air Commanders reverted to being responsible for raising, training and sustaining combat capabilities of each of their services and the reconstitution of their forces following joint employment. A new joint staff group at HQ JOC would plan and conduct operations, as well as determine rotation cycles for forces deployed overseas on enduring operations. For the first time, there would be only one ADF operational-level headquarters.

An important question for the Army was how best to prepare forces generically and, more specifically, when the CDF assigned forces to CJOPS and HQ JOC for joint employment. At the operational level, two headquarters commanded the combat units of the Army – Land Headquarters in Sydney and HQ 1st Division in Brisbane. The establishment of HQ JOC forced the rationalisation of these headquarters and the reorganisation of their subordinate formations and units.

The Army had not changed its organisation significantly since the Hassett Review in 1970 recommended the introduction of the functional command structure.¹⁸ Almost 40 years later, informed by a wealth of overseas operational experience and forced to interface with HQ JOC, the Army instituted another fundamental reorganisation – the Adaptive Army initiative.

17 Foundation Warfighting (Training) comprises individual and collective skills, knowledge and attitudes fundamental to capability and readiness for the broad range of operations required to conduct adaptive campaigning. In essence, it is the ability to sustain close combat for a specific purpose against lethal and adaptable opponents while positively influencing the attitudes and well-being of the populace.

18 *The Command and Organisational Structure of the Army in Australia*, Report of the Army Review Committee in 1970 (known as the Hassett Review), Department of Defence, Canberra, 1 January 1971.

Genesis

The genesis of what would become known as the Adaptive Army initiative was a confluence of ideas and events in late 2007. Lieutenant General Ken Gillespie, the Vice Chief of the Defence Force (VCDF) and Major General David Morrison, Head, Military Strategic Commitments, and recent Commander of the Australian Defence College, believed that the high tempo of operations since 1999 and the nature of modern conflict as articulated in the capstone doctrine *Adaptive Campaigning* required the Army to streamline its generic and specific force preparation for joint employment and speed up its learning loops.¹

Since a major intervention into East Timor in 1999, the Australian government had deployed land forces to quell outbreaks of violence at the invitation of regional neighbours and also participate in campaigns in Iraq and Afghanistan at the invitation of traditional allies. Thus, the Army had been forced to broaden its focus from the defence of the Australian mainland from hostile incursions to preparing and deploying combined arms task forces regionally and internationally, often at short notice.

Gillespie and Morrison assessed that the Army needed to align itself more effectively with HQ JOC to achieve rapid, strong and smart land force projection. There was also a requirement to restructure Army Headquarters to accommodate a ten-year development plan known as the 'Hardened and Networked Army' initiative. Lieutenant General Peter Leahy, then Chief of Army, had secured resources from the government for:

- the development and implementation of new force structures to support nine combined arms battlegroups
- increased overall readiness for the Army
- the re-rolling of the 3rd Battalion, the Royal Australian Regiment (3 RAR), from a parachute battalion to generate a second mechanised infantry battlegroup by 2011 the relocation of a combined arms force to Adelaide (1200 personnel), increasing the Army by 1485 personnel
- improved communication networks from newly acquired radios for individual soldiers through to battle management systems for commanders a refocused Army Reserve to provide approximately 2800 high-readiness Reservists to support the Army's front-line deployable units (High Readiness Reserve, the Active Reserve and the Standby Reserve)

¹ Australian Army, *Adaptive Campaigning, Army's Future Land Operating Concept*, Army Headquarters, Canberra, 2009; interview with Major General D.L. Morrison, 3 December 2009.

Coincidentally, Colonel Greg Bilton's establishment review of Army Headquarters in 2007 once again raised the concept of splitting the headquarters into a division that would run the Army on a day-to-day basis under the Deputy Chief of Army (DCA) and a division that would develop the Army's future doctrine and capabilities.²

In 2008 Gillespie and Morrison would have their opportunity to implement change. Morrison would become DCA in January and Gillespie would become the Chief of Army (CA) mid-year. Lieutenant General Peter Leahy recognised the pressure for change but was reluctant to lose a major general's position by removing a headquarters from the Army's chain of command.³ He was also conscious of the difficulty of convincing retired generals of the need to change structures that they had put in place in the 1970s and which, from their perspective, had served the Army well since then.⁴ His legacy and major achievement would be the Hardened and Networked Army initiative. He would leave further structural reform to Gillespie.

In early 2008, Gillespie and Morrison discussed the importance of rationalising the work of the DCA and Director General Preparedness and Plans – Army (DGPP-A), as well as Leahy's concern over losing a major general's position. Both DCA and DGPP-A were overcommitted and overworked, which inevitably led to inefficiencies. Brigadier Paul Symon, DGPP-A, would later describe this situation as 'span paralysis'.⁵ The tempo for decision-making was so high and the range of responsibilities so vast that both DCA and DGPP-A simply did not have the time or staff resources to inform themselves sufficiently to make decisions in a timely way.

Those staff members whose focus was on future Army capability development were also not being employed effectively. While their colleagues running the day-to-day business of the Army were exceptionally busy, the capability development team's work focused on longer term future land warfare and the pace was far more relaxed. While this longer term view was important, the Army needed to focus on its shorter term capability development in a two to ten-year timeframe, an aspect that was being almost entirely neglected.⁶

Morrison suggested appointing a major general in Army Headquarters to head the Army's capability development. This position would absorb the immense amount of committee work required to service the Defence Capability Development Program and also separate the Army's long and medium-term development from day-to-day management that included servicing the burgeoning departmental governance regime.⁷ Gillespie went to Leahy immediately and secured his agreement to commence a process of fundamental structural reform in anticipation of the former's assumption of command of the Army in early July 2008.

Secret Planning

Overt planning for these changes could not begin until the Defence Minister and the CDF, Air Chief Marshal Angus Houston, announced Gillespie's appointment.⁸ Brigadier Paul Symon,

2 Interview with Colonel Greg Bilton, 10 December 2009.

3 Interview with Major General D.L. Morrison, 3 December 2009.

4 Interview with Major General M.D. Slater, 5 August 2010.

5 E-mail, Major General P.B. Symon, 23 April 2010.

6 Annotations on penultimate draft, Lieutenant Colonel M. Ryan, 30 August 2010.

7 See Defence Capability Development Manual at: <http://www.defence.gov.au/publications/dcdm.pdf> for. The Australian National Audit Office (ANAO) defines governance as the processes by which organisations are directed, controlled and held to account. This broadly covers corporate and other structures, culture, policies, strategy and ways of dealing with various stakeholders. It also encompasses the manner in which organisations acquit their stewardship responsibilities by being open, accountable and prudent in decision-making.

8 Interview with Major General D.L. Morrison, 3 December 2009.

DGPP-A, convened a small, secret compartment of staff he referred to as '4D' at AHQ.⁹ He and Colonel Greg Bilton, who had conducted a number of reviews of Army organisational structures, had already 'white-boarded' several models.¹⁰

In February 2008, Symon's staff group began scoping options for restructuring the Army, also considering various models and processes for achieving this.¹¹ Symon had deliberately introduced the '4D' concept – based on time as the fourth dimension – to this work because creating time to make sound decisions was foremost in his group's thinking. Among the group's members were several with considerable operational experience who were critics of the status quo, and who had considered carefully the temporal dimension of military operations. This was the foundation concept for the 4D group. The group was concerned that adversaries in Iraq/Afghanistan were learning and adapting faster than the ADF. Yet, within the Army's command and control arrangements, no single person was responsible for the immediate, short, medium or long learning loops. Most lessons were simply being passed by e-mail from junior officers in the Middle East and Afghanistan to their peers preparing for operations. This ad hoc arrangement of peer information exchange, that probably dated from the Korean War, had to change for the Army to improve as an institution.

The 4D group set out from the beginning to ensure that the Army learned and adapted faster than the hostile groups that Australian forces faced on operations in the Information Age. The core idea was to establish a systemic approach to adaptation across the Army so that this culture would permeate generic and specific force preparation before forces were assigned to CJOPS for joint employment. Traditionally, the Army learned its force preparation lessons in a fragmented, ad hoc manner following deployment. It was time to move the Army's adaptation cycles from tactical and sporadic learning to strategic, systemic and instinctive institutional learning and lesson application.¹²

The second temporal aspect that influenced the thinking of the 4D group was the need to separate, while at the same time harness, the fast-learning and 'action-oriented' function of Army Headquarters and the development of long-term and medium-term plans and future concepts. In terms of human behaviour, some people perform well in day-to-day management and in immediate crisis situations while others are much better disposed to deal with contemporary analysis and anticipation of the future.¹³ The co-location of the Army's capacity to take prompt, strong and smart action with its capacity to contemplate and prepare for the future, including maintaining a technological competitive edge, would optimise the preparation and projection of land forces.

Just as important were the Army's linkages to other organisations. At the strategic level, a habitual and mutually respectful relationship had to exist with the Military Strategic Commitments Division where the government's guidance and the ADF's future operating environments and contingencies were interpreted and communicated. At the operational level, CJOPS and his headquarters had to enjoy a close collegial relationship with the Army for operational-level planning, specific force preparation and deployment. It was important to avoid duplication.

9 4D is code for time – the fourth dimension. In mathematics the fourth dimension, or a four-dimensional (4D) space, is an abstract concept, obtained by taking the rules of three-dimensional space and generalising them to a space with one more dimension. It has been studied by mathematicians and philosophers for almost 200 years, both for its own complexity and for the insights it offers into mathematics and related fields.

10 Interview with Major General P.B. Symon, 22 April 2010.

11 Of interest was an early model (later discarded) that assigned High Readiness Command to CJOPS, leaving Forces Command and Special Operations Command under CA. Arguably, this innovation would have given CJOPS the responsibility, accountability, authority and resources to begin specific force preparation of assigned land forces immediately after the CDF assigned them to him. As a result, he and HQJOC would potentially have had the opportunity to rehearse a JTFHQ with its assigned land forces and possibly maritime, land and air force elements before deployment rather than each service rehearsing separately and transferring prepared forces to HQJOC just prior to deployment.

12 Annotations on penultimate draft, Lieutenant Colonel M. Ryan, 30 August 2010.

13 Interview with Major General P.B. Symon, 22 April 2010.

The term 'Adaptive Army' emerged from consultations between Brigadier Symon and Lieutenant Colonel Mick Ryan, one of his senior staff officers. Ryan was impressed by the capstone doctrine Adaptive Campaigning, but was also concerned that the adaptive approach explicit in the doctrine focused only on operations. He asserted that the Army had to have an adaptive ethos in order to generate flexible forces to conduct adaptive campaigning. Symon accepted these arguments and members of the 4D compartment adopted the term 'Adaptive Army initiative' to describe their work.¹⁴

Past Structural Reform

The last Army restructure occurred in 1971, a time when the Army's participation in the Vietnam War was ending and Australia was changing its forward defence posture in South-East Asia to what would be later described in the 1987 White Paper as 'defence-in-depth' of the Australian mainland. With no major overseas commitments in prospect, the government sought to reduce Defence expenditure by consolidating and reducing the size of the Defence bureaucracy and the services. It would be 16 years before the government would next direct the Army to project land forces overseas.¹⁵

In 1970 the Military Board appointed Major General Frank Hassett and a small civil-military staff group to examine the overall command and organisation of the Army. The objectives of Hassett's Army Review Committee were to achieve greater efficiency and economy, paying particular attention to the existing command and logistics systems, as well as the corps structure and organisation of Army Headquarters.¹⁶ Hassett sought a structure for the Army that suited the dual strategic requirements of having land forces ready to defend Australia and its territories, as well as for employment in the near region in defence of the mainland.

Hassett transformed the Army into a functional hierarchy: Army Headquarters, Field Force Command, Training Command and Logistic Command. The commands had the following functions:

- **Army Headquarters:** command and generic force preparation, including modernisation and sustainability
- **Field Force Command:** (later renamed Land Command): command of combat forces and their generic preparation, as well as specific preparation for operations, protection, deployment, employment, rotation and redeployment of land forces
- **Training Command:** individual training using an approach to training based on central management of resources and the US Army's evolving competency-based training system
- **Logistic Command:** sustainment of land forces on exercises and operations, as well as reconstitution of land forces following operations

Importantly, the Army Review Committee separated headquarters and organisations that would be responsible for land force projection from the day-to-day responsibility and accountability for providing garrison services in Army bases. New organisations known as Military Districts would provide the goods and services needed to sustain and administer the Army in barracks. In addition, Army Headquarters would retain responsibility for command, capability development and personnel administration, as well as management of the Army's infrastructure, weapons, equipment and fleets of vehicles.

Thus, in 1973 the Army began a transition from a decentralised, disconnected, state-based structure that originated in the colonial era to a centralised, connected and functional system for generating land forces for operations. The new functional structure simplified responsibilities for

14 Annotations on penultimate draft, Lieutenant Colonel M. Ryan, 30 August 2010.

15 The Army embarked an infantry company group at short notice in May 1987 to sail to the waters off Fiji as a contingency in case Australian nationals and other approved persons had to be evacuated from Fiji in the aftermath of a military coup that had the potential to precipitate a breakdown in law and order.

16 Hassett Review, p. v.

training and preparing land forces and individuals for operations, as well as for logistic support. These arrangements anticipated sufficient time to mobilise, train, administer, load and deploy land forces for conventional war.

In 1979 the Chief of the General Staff, Lieutenant General Don Dunstan, concluded that the Army must be ready to meet government requirements to deploy land forces quickly in response to regional or international emergencies. This required a rapid response brigade. 'I could not guarantee,' he said, 'to provide a task force of two battalions in less than about three months, or a battalion group in less than a month.'¹⁷

The Soviet Union's invasion of Afghanistan and the Chinese attack on Vietnam in 1979 created the political will in 1980 to allow Dunstan to begin establishing the Operational Deployment Force (ODF). Its structure and capability would evolve over the following years.¹⁸ Dunstan also initiated plans to establish a parachute battalion and a mechanised battalion, capabilities that would take ten years or more to develop. A decade later the 1987 White Paper verified the need for the ODF, and also confirmed that the Army should maintain six infantry battalions, including an airborne, a mechanised and a motorised battalion, although money for six full-strength regular battalions would not be forthcoming for another 20 years until Lieutenant General Leahy's Hardened and Networked Army initiative won sufficient funds from the government to establish eight battalions.

In summary, the Hassett Review moved the Army from its traditional state-based structure to an organisation that began evolving to centrally managed delivery of command, training and sustainment functions for operations. The day-to-day provision of garrison services for the Army in barracks remained with state-based Military Districts. Geographic legacies continued. The Military District headquarters, as well as divisional headquarters, continued to occupy historic buildings in capital cities. While HQ Field Force Command remained in a heritage building at Victoria Barracks in Sydney, HQ Training Command was sited in a leased office accommodation in downtown Sydney, and Logistic Command occupied a leased office building in Melbourne.

In the 1990s, the Army experimented with a reorganisation known as 'The Army of the 21st Century' (A21). This was not a successful reform. It was constrained by strategic guidance that restricted the Army's vision to the defence of the Australian mainland. More particularly, it was overtaken by the momentous events of 1999 when the Army had to project a brigade group with full logistic support to East Timor at short notice. The 2000 Defence White Paper made A21 obsolete. The 4D group in 2008 had much to learn from the failed A21 development process in 1999.¹⁹ The Adaptive Army initiative had to comply with government strategic guidance or suffer the same fate as A21.

By 2008, the Army, under pressure from successive governments to achieve saving through asset sales, had consolidated some training and sustainment organisations. HQ Field Force Command had become Land Headquarters (LHQ) and was accommodated at Victoria Barracks, Sydney, adjacent to HQ Training Command, which occupied a new building. HQ Logistic Command had been absorbed into HQ Joint Logistic Command (HQ JLC), its strategic-level headquarters staff in Canberra and operational-level supply chain headquarters staff in new and heritage buildings at Victoria Barracks, Melbourne.

Contractors, managed by the Defence Support Group (DSG), were now delivering garrison services in all Army bases. The Military District headquarters had disappeared following the Commercial Support Program initiative. HQ 1st Division had moved into a purpose-designed building at Enoggera in Brisbane. HQ 2nd Division, a Reserve headquarters, commanded Army Reserve brigades around Australia from purpose-built accommodation at Randwick Barracks, Sydney.

17 Lieutenant General D.B. Dunstan, CGS Address to Army Staff College, 1980, AWM: COL (OA) papers.

18 For a description of the formation of the ODF see David Horner (ed.), *Duty First, The Royal Australian Regiment in War and Peace* (2nd edn), Allen & Unwin, Sydney, 2008, Chapter 13.

19 For a description of the A21 reorganisation initiative see Albert Palazzo, *The Australian Army: A History of its Organisation, 1901-2001*, Oxford University Press, Melbourne, 2001.

The trend up to 2008 had been to consolidate the Army's manoeuvre brigades in the north, while training establishments were consolidated in the south and south-east. Higher readiness Regular brigade groups were based in Darwin, Townsville and Brisbane – a northern cordon – while major training establishments were consolidated in:

- Canungra, located in the Gold Coast Hinterland, 90 kilometres south of Brisbane²⁰
- Puckapunyal, located 100 kilometres north of Melbourne²¹
- Albury-Wodonga, located on the southern border between New South Wales and Victoria²²
- Kapooka, ten kilometres north-west of Wagga Wagga, mid-way between Sydney and Melbourne²³

In addition, Simpson Barracks in suburban Melbourne was home to the Defence Force School of Signals and Defence Force School of Music, units belonging to the Defence Command Support Training Centre (DCSTC).²⁴

Thus, the die was cast for the geographical distribution and consolidation of land forces and their training, logistic and administrative support. The Adaptive Army initiative was more about responsibility, authority, accountability and resources than relocation and consolidation. The aim was to achieve the best structure for the roles and responsibilities for generic and specific force preparation of land forces for joint employment. The first phase in 2008 would involve deriving options and agreeing on an organisational model and then implementing the chosen model in 2009 and 2010.

Choosing the Model

Once the Defence Minister, Joel Fitzgibbon, and CDF, Air Chief Marshal Angus Houston, had announced Gillespie as the CA-elect, Gillespie and Morrison expanded the 4D compartment so as to harness the intellect and experience of senior Army officers to examine and derive models for reorganising the Army to better prepare and project land forces. Brigadier Symon convened and led a preliminary workshop in mid-February 2008 to begin scoping and designing the next steps of the change process. Key contributors were Colonels Greg Bilton and Mike Tucker and Lieutenant Colonel Mick Ryan. They decided to conduct four workshops in May 2008:

- Workshop 1 – Operations
- Workshop 2 – Personnel Management and Logistics
- Workshop 3 – Resource Management and Governance
- Workshop 4 – Systemic Impacts (second and third order impacts of the Adaptive Army initiative on outside Defence and ADF organisations and functions)²⁵

This core group comprised representatives of a generation of officers primed and ready for change. All had operational experience and several had been commanders of land forces overseas. They had been disappointed with the performance of headquarters and frustrated by

20 Home to the Defence Intelligence Training Centre and HQ Regional Training Centres.

21 Home to the Combined Arms Training Centre, Land Warfare Development Centre, and three of the five principal combat arms schools, including the School of Armour, the School of Artillery and Combat Command Wing. The Army School of Transport also maintains its driver training wings and the Bushmaster Infantry Mobility Vehicle driver training program at Puckapunyal.

22 Home to the Army schools of Logistic Operations, Electrical and Mechanical Engineering, Transport, Ordnance and Health. The ADF Chaplains' College is also located in the Albury-Wodonga area.

23 Home to the Army Recruit Training Centre (ARTC) and Army Adventurous Training School.

24 Defence Command Support Training Centre (DCSTC) commanded the Defence School of Signals (DFSS), Defence School of Music (DFSM), Defence Police Training Centre (DPTC), Defence Force School of Languages (DFSL) and Defence Intelligence Training Centre (DIntTC).

25 This workshop was not conducted.

cumbersome traditional processes that had not worked well in preparing land forces and Army contingents for overseas service. They believed that their experiences and those of their peers who had been in the same situations had created a latent constituency of officers who would embrace the Adaptive Army initiative enthusiastically.

Morrison appointed Symon to lead the change process. He was a good choice. He had the credibility of having worked in senior staff positions in Canberra and the contemporary tactical, operational and strategic-level experience to convince his peers, as well as generals, both serving and retired, and the rest of the Army, that change was both necessary and achievable amidst a high operational tempo. Symon decided to convene the first two-day workshop to examine organisational models that he and his staff had begun refining in the preliminary workshop and their potential impact on the preparation of forces for operations.²⁶

Symon would have the challenging task of pulling the Army's brigadiers together to think hard about different organisational models. He had to shape and facilitate the process, as well as hold it together under the pressures that strong and competitive personalities would exert. At his elbow would be an organisational psychologist from DSTO, Cherylene Fleming, who would advise him on developing adaptive command and control arrangements for the Army, as well as 'reading' the mood during sessions and managing workshop participants. She would assist Symon by interpreting the communication and body language of participants and suggesting ways to encourage more harmonious and constructive processes.²⁷ Fundamental to the thinking of the 4D/Adaptive Army initiative was the work of DSTO scientist Dr Anne-Marie Grisogono.²⁸

Workshop 1 – Operations, 12-13 May 2008

The first workshop, titled the 'One-Star Workshop', was conducted at the Joint Decision Support Simulation Centre (JDSSC) at RAAF Base Fairbairn in Canberra on 12–13 May 2008.²⁹ The JDSSC consisted of a team of analysts using a range of analytical and simulation tools and experimentation techniques to provide scientific assessment of new strategic and operational doctrine. The JDSSC was designed to be a node in a network with access to other simulation and experimentation centres operated by DSTO, the services, Australian industry and Australia's overseas partners.

On the first day, Lieutenant Colonel Mick Ryan, SO1 Preparedness, briefed participants on a model for AHQ and presented and explained two models for reorganising the Army's functional commands. Ryan was also a good choice. He had a deep knowledge of complex adaptive systems and was a gifted communicator of the theory and practical application of those systems. Like Symon, Ryan had commanded on contemporary operations and had the credibility to inform the thinking of participants and secure commitment.

26 Participants in the first 4D Workshop held at JDSSC on 12–13 May 2008 were: Major General David Morrison, Brigadier Paul Symon, Brigadier David Creagh, Brigadier Mick Moon, Brigadier Don Higgins, Brigadier Gus Gilmore, Brigadier Jim Simpson, Brigadier Gerard Fogarty, Brigadier Mal Rerden, Brigadier Mark Bornholt, Brigadier Bruce Cook, Colonel Mike Tucker, Colonel Peter Short, Colonel Mark Brewer, Colonel Paddy Evans, Colonel Chris Field and Mr Chapman, DGCMP-A.

27 Interview with Major General P.B. Symon, 22 April 2010.

28 Annotations on penultimate draft, Lieutenant Colonel M. Ryan, 30 August 2010. See Anne-Marie Grisogono and Alex Ryan, 'Designing Complex Adaptive Systems for Defence', Land Operations Division, DSTO, 2005; Anne-Marie Grisogono and Alex Ryan, 'C2 Concepts, Theory and Policy, Networks and Networking', Command and Control Research and Technology Symposium (2007 CCRTS), 'Adapting C2 to the 21st Century: Operationalising Adaptive Campaigning', 2007.

29 The JDSSC was developed as a partnership between Capability Development Executive (CDE) and the Defence Science and Technology Organisation (DSTO) in 2007. The JDSSC was designed to assist Canberra-based strategy and capability development decision-makers by providing information on complex Defence strategy and capability issues.

Both models that Ryan introduced cut the Army's functional commands to three: Readiness Command, Forces Command and Special Operations Command. Each had variations on roles and responsibilities (See Figure 1 and Figure 2 for Model 1 and options and Figure 3 for Model 2).

Figure 1 Functions of Force Projection

Function	Elements
Generic Preparation	Military capability that is made up of force structure, readiness, mobilisation and sustainability
Command	Command, control, communications and computer systems
Specific Preparation	Concentration of force elements in mounting or home bases, reconnaissance, reinforcement, training, administration and issue of equipment and stocks
Deployment	Concentration of personnel and matériel, loading, movement of force elements to area of operations and, best effect arrival and pre-positioning
Protection	Intelligence, surveillance, contingency rehearsal and rapid response
Employment	Conduct of operations that may include maintaining deterrent presence, manoeuvre and application of firepower
Sustainment	Planning and carrying out the movement of supplies and maintenance of forces through a supply chain
Rotation	Reinforcement, relief, resting, retraining, re-equipping and redeployment of force elements
Redeployment	Protected movement to specified locations, normally home bases
Reconstitution	Return to required level of military capability

Figure 2 Model 1 – Operations Workshop

Readiness Command	Collective combined arms training and assessment in order to prepare and deploy tailored land force elements for known operations and contingencies. Composed of <ul style="list-style-type: none"> • Training, Assessment and Force Preparation Group. Preparation and execution of combined arms, Army and joint task force headquarters training, assessment and certification, as well as support for force preparation and issue of mission specific equipment; • Operational Deployment Group. All tailored combined arms teams/headquarters that have been identified for a known operational commitment; and • Ready Deployment Group. All tailored, combined arms teams/ headquarters that have been identified for contingencies for the reinforcement of extant operations
Forces Command	Individual and collective Corps training and assessment in order to prepare land forces for the conduct of combined arms training (see Figure 2 for options)
Special Operations	Provide Special Forces across the operational continuum for joint, combined and interagency operations

Model 1 was a fundamental change which separated the functions of generic and specific force preparation.³⁰ Forces Command would conduct generic preparation of land forces in preparation for transferring them to Readiness Command for specific force preparation before transfer to CJOPS and HQ JOC for deployment and joint employment with maritime and Air Force elements.

³⁰ **Generic force preparation:** military capability comprising force structure, readiness, mobilisation and sustainability. **Specific force preparation:** concentration of force elements in mounting or home bases, reconnaissance, reinforcement, training, administration and issue of equipment and stocks.

For Model 1, selected units, sub-units and individuals would follow a cycle of assignment from Forces Command to Readiness Command. The cycle would be driven by a two-month assignment for specific force preparation in readiness for deployment to ongoing and anticipated operations, or an eight-month assignment in readiness for the most likely operational contingencies. The move from a six month to an eight-month cycle was important primarily for ensuring that land forces had more time at home bases so they could complete 'foundation warfighting training' prior to commencing specific force preparation for rotation to their next operation.

Figure 3 Model 1 – Options for Forces Command

<p>Forces Command Option 1</p>	<p>A headquarters under Commander Forces Command (COMD FORCOMD), led by the Deputy Commander Forces Command (1 Star), would command two of the three regular brigades while the other regular brigade was assigned to Readiness Command. A divisional headquarters under COMD FORCOMD, led by Commander 2nd Division (2-Star), would command six reserve brigades. Five brigadiers would command the following brigades and groups:</p> <ul style="list-style-type: none"> • 16 Aviation Brigade • 17 Combat Service Support Brigade • Forces Command Support Group • Training schools • IET Schools (RMC and Recruit Training)
<p>Forces Command Option 2</p>	<p>Division Command led by a major general commanding five regular brigades and Direct Command Units (DCU), as well as six Reserve Brigades. Three brigadiers commanding three groups:</p> <ul style="list-style-type: none"> • Training Schools • IET Schools • Forces Command Support Group

Model 2 was more conservative, but divided the Army's structure into a Regular Army formation and a Reserve Army and training formation. In effect, HQ 1st Division in Brisbane would be renamed Readiness Command and keep its three Regular brigades (1, 3 and 7) and have assigned the other two Regular specialist aviation and logistic support brigades (16 and 17). It would also have a Manoeuvre Support Group comprising two signals regiments, an intelligence battalion and a ground liaison group, as well as an air defence, an engineer support, and a surveillance and target acquisition regiment.

Forces Command would comprise all Army Reserve units, including the Regional Force Surveillance Units, under command of Commander 2nd Division. Three brigadiers would command:

- Land Combat Training Brigade
- Land Warfare Development Centre
- Royal Military College (now including Army Recruit Training Centre and the School of Music)

Model 2 shifted significant power and status from Land Command in Sydney to HQ 1st Division in Brisbane. While not described in these terms, Readiness Command would be responsible for both generic and specific force preparation of land forces for joint employment, leaving Forces Command to be responsible for all Regular and Reserve individual training, and the collective training of the Army Reserve and some specialist Regular Army units.

Brigadier Symon facilitated the workshop with information presentations from Lieutenant Colonel Ryan and scenario-based discussions and problem-solving (war games). The three war games involved case studies of how the models would work in three historical scenarios:

- a low-tempo army conducting a large annual field exercise each year
- Operation Astute – the short-notice intervention in Timor Leste in 2006
- Operation Warden – the short-notice intervention in East Timor in 1999³¹

Each participant had the opportunity to comment on each of the models and to offer opinions. At the end, all participants voted on their preferred model. There were differences over how much change was required.³² Ultimately there were more questions than answers, but there was also some important agreement. There was consensus that a Forces Command approach was desirable and feasible because the Army's current command and control arrangements were not appropriate for either a high or low-tempo army. The Chief of Army's Preparedness Directive (CAPD) would guide command and control arrangements for land forces at various states of readiness for operations. Major General Morrison summed up and directed Symon to convene another workshop in three weeks' time that would build on the findings and recommendations of the first workshop and focus on personnel management and logistic support.

An important theme that emerged from this workshop was that the Army's individual training system (run by Training Command) was world class, but that the collective training and assessment (including tracking outputs from resource inputs) under LHQ was not optimal. Therefore, a key concept for Forces Command was applying the Training Command methodology to all individual and collective training in a single training model or continuum. This aspiration was confirmed later when Lieutenant General Gillespie appointed Major General Ash Power, Commander Training Command, to establish Forces Command.

Back Brief – 27 May 2008

On 27 May, Symon presented the results of the first workshop to Gillespie. He confirmed the preference for a Readiness Command (specific force preparation) and a Forces Command (generic force preparation that amalgamated individual and collective training into one continuum). The key difference lay in whether Readiness Command would retain command of higher readiness formations and units. There was also a hybrid model discussed that left Readiness Command commanding the three Regular brigades and a force preparation unit – Combat Training Centre (CTC) and 39 Personnel Support Battalion (39 PSB) – and Forces Command commanding the rest of the Regular and Reserve formations.

At this time, Gillespie was drawn to the hybrid model that gave one major general command of three Regular brigades, as well as the means to prepare and certify their force elements for operations. Forces Command would prepare force elements for assignment to deploying forces from the brigades. Its main focus would be conducting collective and individual training in a continuum and introducing new capabilities into service.

The first workshop had confirmed that a significant cross-section of senior officers in the Army was ready for change and accepted that force preparation should be separated into generic and specific, and that individual and collective training should be combined. Beyond the acceptance of these two changes there was still some way to go to achieve consensus on a preferred structure and command and control arrangements to implement these changes.

31 Role players were: Brigadier Gerard Fogarty (CA), Brigadier David Creagh (DCA), Brigadier Mick Moon (Forces Command), Brigadier John Calgari (Readiness Command), Brigadier Don Higgins (Commander SOCOMD) and Colonel Mike Tucker (Director Military Strategic Commitments). There were no role players for CDF, VCDF, CJOPS, CJLOG or Head National Operations, Defence Support Group (HNO, DSG), all of whom were stakeholders in preparation of land forces for operations.

32 Interview with Major General P.B. Symon, 22 April 2010.

Workshop 2 – Personnel Management and Logistic Support, 6 June 2008

Symon hosted and facilitated the next workshop, held on 6 June, which sought to refine the two models, and then have participants vote for their preferred model at the end. While the first workshop had focused on the operational implications of the models, this workshop examined personnel management and logistic implications. The day began with selected participants briefing those attending on six aspects of the models:

- integrating the Future Land Warfare Branch at AHQ with the Land Warfare Development Centre, located in Puckapunyal
- moving the Aviation Training Centre to under command 16 Aviation Brigade
- moving the Army Logistics Training Centre to under command 17 Combat Service Support Brigade
- aggregating and managing miscellaneous direct command units within Forces Command
- incorporating CTC and elements of 39 PSB into the Training, Assessment and Force Preparation Group in Readiness Command

The content and discussion prompted by these briefs became inputs as participants debated and refined both models. Participants also discussed a number of scenario-based problems as a means of testing Model 1 and Model 2.³³ Colonel David Luhrs, representing the Director-General Personnel (Management), developed a range of scenarios and presented them on the day. The problems took the form of six questions:

- What are the implications for personnel when force elements deploy in January (during the middle of the annual personnel posting cycle)?³⁴
- What are the implications for employment/deployment of Army Reserve organisations or personnel under the revised command and control arrangements?
- How does the Army align its posting cycle with the requirement to cycle personnel through Readiness Command and Forces Command?
- How does the Army conduct individual training in the new Functional Command structure?
- How does the Army align the deployment cycle within Readiness Command with the changes in command of units and sub-units?
- How are personnel in critical trade groups managed in the new Functional Command models, and how is asset versus liability to be managed?

Importantly, participants also discussed the logistics support implications of Model 1 and Model 2 should the Army have to establish a supply chain at short notice in the near region in support of a joint task force (JTF) based on a brigade group assembled from force elements based in Townsville and Darwin.

At the end of the workshop, participants voted 60:40 in favour of an amended Model 1 that involved splitting generic and specific force preparation. There was strong support for Forces

33 Participants in Workshop 2 were: Major General David Morrison, DCA; Brigadier Paul Symon, DGPP-A; Brigadier David Creagh, TC-A; Brigadier Mick Moon, Land Command; Brigadier Nick Bartels, 16 Avn Bde; Brigadier Jim Simpson, CCMA; Brigadier Mal Rerden, COMD LWDC; Brigadier David Saul, 17 CSS Bde; Brigadier Bruce Cook, DGRES-A; Mr Chapman, DGCMP-A; Colonel David Luhrs, DGPERS-A; Dr Mike Brennan, DSTO; Colonel Lester Sutton, SOCOMD; Colonel Mick Tucker, DOPS-A; Colonel Hicks, DGPERS-A, Colonel Mark Brewer, HQ 1 Div; Colonel Paddy Evans, HQ 2 Div; Colonel Chris Field, DCD DGFLW-A; Colonel Bottrell, DLOG-A; Captain Miko, RAN; JLC; Colonel Michael Mahy, LHQ; Colonel Alexander, TC-A; Lieutenant Colonel Laurie, HQ 1 Div – G4; Lieutenant Colonel Smith, DFS-A; Lieutenant Colonel Ryan, DOPS-A; Lieutenant Colonel Walk, DLOG-A; Lieutenant Colonel O’Leary, TC-A; Lieutenant Colonel Mick Ryan, SO1 Preparedness, PP-A.

34 The deployment of the 1 RAR Group to Somalia at short notice in December 1992–January 1993 was an historic example of personnel churn and disruption during pre-deployment training and administration. See Breen, A Little Bit of Hope.

Command to assume responsibility for generic force preparation (individual and collective training) and for Readiness Command to take responsibility for specific force preparation for short-notice deployments and maintaining high readiness forces for the most likely contingencies.

The major unresolved issue was the short-notice and cyclic assignment of force elements to and from Forces Command and Readiness Command. Participants were also unhappy with the title 'Readiness Command', arguing that Forces Command would have to maintain levels of readiness for CA. Equally, Readiness Command would have to maintain levels of readiness for ongoing and anticipated operations, as well as likely contingencies for CJOPS. Thus, both commands would have to maintain and report on readiness to CA and CJOPS respectively. Once again there were many unanswered questions. Despite this, Morrison decided to go ahead with the next workshop.

While Morrison conferred with Gillespie, Symon and his staff continued work on the missions and functions of Readiness Command and Forces Command, as well as models for AHQ. In order to fully test the outcomes of the next workshop, Symon also began work on establishing what became known as a Red Team workshop for 7 July. The Red Team would comprise senior officers who had not participated in any of the workshops. They would examine and critique the results of the next workshop to be held on 27 June.

Figure 4 Model 2 – Operations Workshop

Readiness Command	Command regular brigades, as well as specialist aviation and logistic support brigades, support Direct Command Units and conduct collective combined arms training and assessment in order prepare and deploy tailored land force elements for known operations and contingencies
Forces Command	Conduct individual training for all army personnel, as well as collective Corps , training and assessment for Army Reserve units and selected regular specialist units in order to prepare land forces for the conduct a combined arms training
Special Operations	Provide Special Forces across the operational continuum for joint, combined interagency operations

Workshop 3 – Resource Management and Governance, 27 June 2008

The next workshop, held on 27 June, followed the same format as its predecessors. Morrison opened with assurances that he and Gillespie were committed to restructuring the Army and that this workshop would build on the results of the previous two workshops by examining resource management and the governance implications of reorganising the Army along the lines of Model 1 or Model 2. Further, it was important that the newly reorganised AHQ had effective and clearly understood command and control relationships with the new functional commands as well as with the VCDF Group, HQ JOC and Joint Logistic Command (JLC).

Participants discussed and amended Model 1 and Model 2. A variety of issues emerged from a scenario-based problem-solving activity based on the 1996 Black Hawk helicopter disaster.³⁵ This time voting went the other way: 40% of participants voted for Model 1, splitting the Army into two commands responsible for generic and specific force preparation and 60% of participants voted for Model 2, the division of the Army into a Regular formation that would prepare and project land forces, and a Reserve Army and individual training formation.

³⁵ On 12 June 1996 Australian Special Forces were conducting an exercise at the High Range Training Area near Townsville to practise the recovery of Australian citizens held hostage by armed terrorists. Six Black Hawk helicopters and 24 aircrew from the 5th Aviation Regiment and 43 soldiers of the Special Air Service were conducting a live-fire air-mobile assault on a simulated terrorist position. As the formation reached the target zone, two helicopters collided. The lead helicopter crashed to the ground upside down and was consumed by fire. The second helicopter entered a flat spin before crash landing in an upright position. It too was destroyed by fire. Eighteen Australian servicemen perished and a further 12 were injured, some critically. Equipment worth \$37 million was destroyed.

Figure 5 - Workshop 2 - Model 1

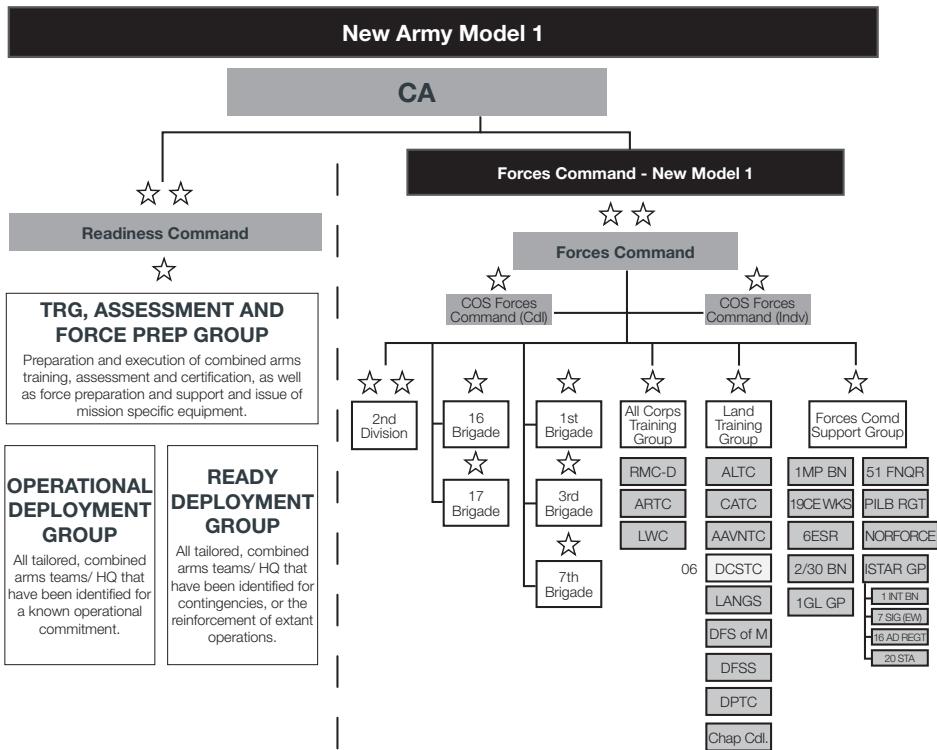

Figure 6 - Workshop 2 - Model 2

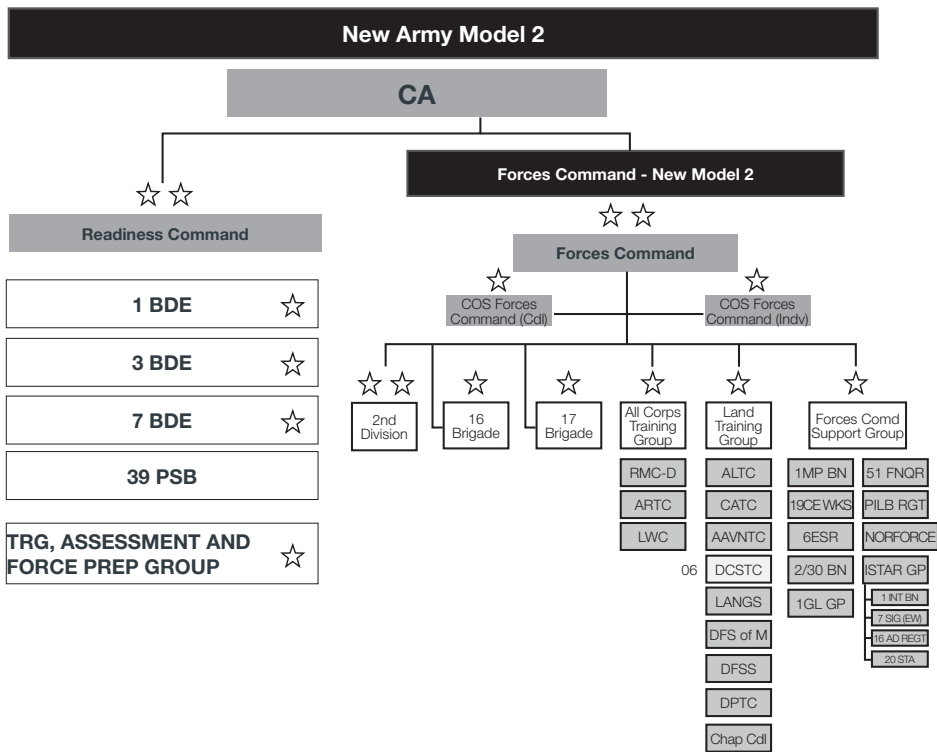

Figure 7 - Workshop 3 - Model 1

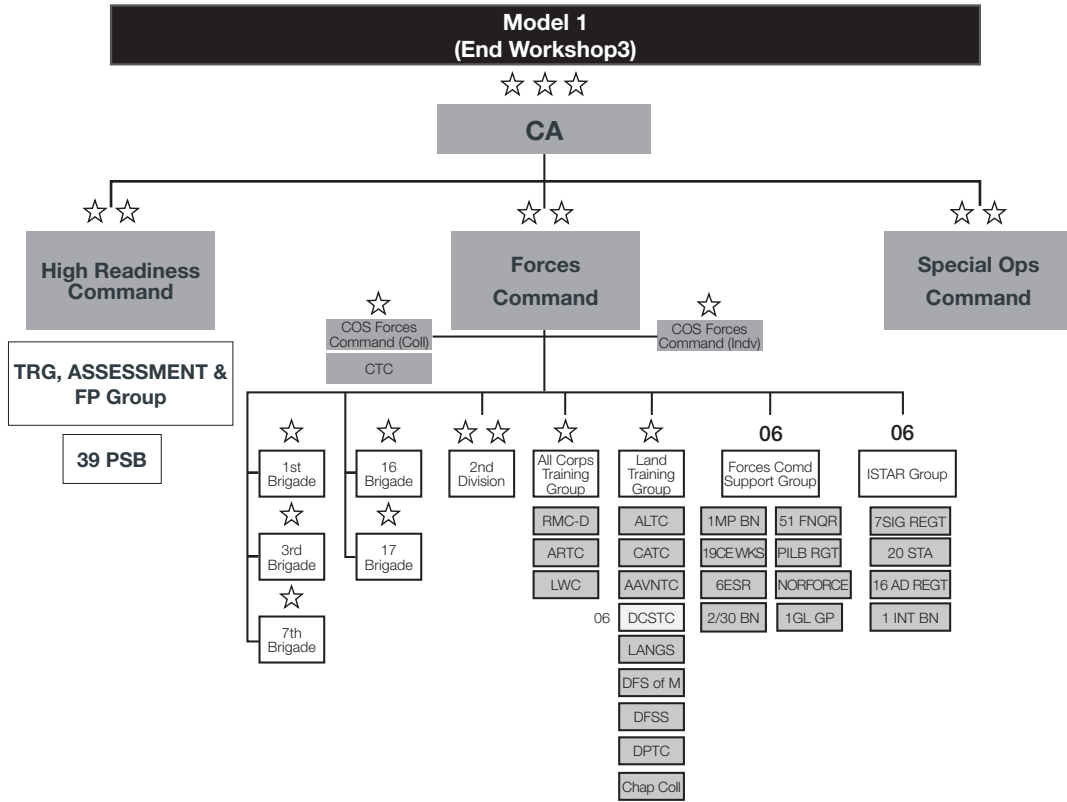
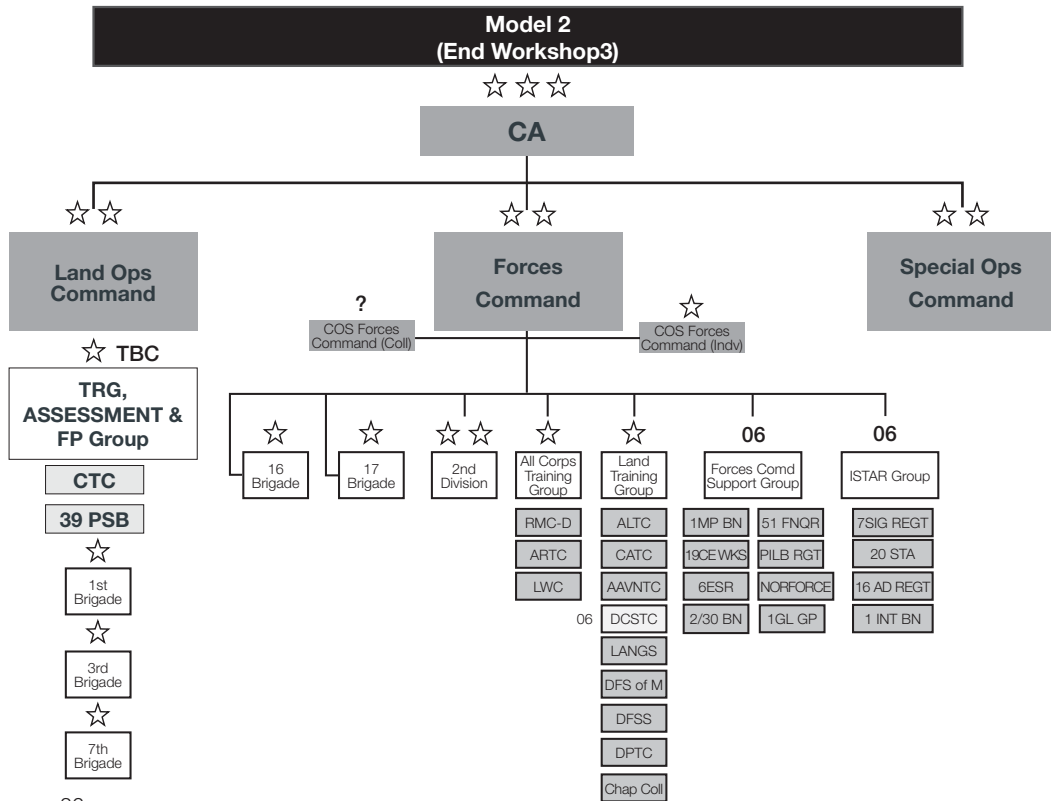

Figure 8 - Workshop 3 - Model 2



The reversal of the vote from Workshop 2 was a watershed. Participants were now voting for significant functional change. Potentially, HQ 1st Division would be transformed from its conventional structure, function and traditional command responsibilities to a mechanism for operational-level planning with HQ JOC and preparing joint headquarters and assigned land forces just prior to joint employment. Its planning and force preparation functions would include:

- assessing the readiness of assigned land forces for operations and/or directed contingencies
- conducting joint and inter-agency planning in support of HQ JOC
- commanding and managing preparation of assigned land forces for operational missions or contingencies
- certifying land forces as ready for combined arms, joint and inter-agency operations
- issuing and maintaining mission-specific equipment to deploying land forces
- providing a certified deployable JTF HQ (two star) for deployment at short notice and preparation to command a major contingency operation offshore
- enabling technical control of deployed land forces on behalf of CA
- providing a common, systematic, force-mounting preparation and post-deployment reintegration process for all deploying land forces

Within the context of governance and resource management, most participants considered the concept of cyclic force assignment between Forces Command and Readiness Command unwieldy and likely to confuse command and control arrangements as well as personnel and resource management between the commands. There was diminishing support for the concept of having force elements on a two-month cycle of specific force preparation for known operations, and an eight-month cycle for likely contingencies. The Army's administrative and resource management systems were not considered sufficiently agile to accommodate this system of cyclic force assignment.

While the three workshops focused discussion on models rather than the status quo, differences of opinion emerged around who would command the bulk of the Regular Army – an amalgamated headquarters in Sydney (LHQ and HQ Training Command) or HQ 1st Division in Brisbane, leaving command of individual training in Sydney. The underlying debate was as much about power and status as function, effectiveness and efficiency.

Importantly, there was continued strong support for creating a continuum of individual and collective training under an amalgamated Forces Command. In practice, this would mean the integration of LHQ and Headquarters Training Command, located in adjacent buildings at Victoria Barracks in Sydney. The issue was whether this new integrated headquarters in Sydney, titled 'Forces Command' in both Model 1 and Model 2, would retain command of the Army's Regular and Reserve combat forces for generic force preparation and only release them to HQ 1st Division for specific force preparation prior to joint employment for existing and anticipated operations, as well as for likely contingencies such as an outbreak of violence in the near region that required the ADF to lead a short-notice intervention.

Further Clarification

The three workshops in May and June revealed divisions among participants on the rationale for change. Some participants also felt that Model 1 (separating responsibilities for generic and specific force preparation) lacked definition and required further explanation. Brigadier Symon, in consultation with Lieutenant Colonel Mick Ryan, Colonel Mike Tucker and officers from LHQ and HQ 1st Division, prepared a discussion paper before convening a Red Team workshop on 7 July at JDSSC.

The discussion paper reinforced the Army's obligation to continuously scan the operational environment and reassess the relevance of its goals and its measures of success and failure and adapt them accordingly. Under new ADF joint command and control arrangements, the Army had become a force provider, not a force employer. The preparation and delivery of land forces for joint employment had to be streamlined. This would require the Army to embed the positive aspects of a more robust readiness culture that had developed out of necessity over the past decade of increased operational tempo. In short, the Army would apply its operational lessons in a permanent way. To do so would require both cultural and organisational change.

The separation of generic and specific force preparation would begin with Gillespie's preparedness directive. For generic force preparation, CA would forecast Army commitments over a five-year period. For specific force preparation, he would forecast Army commitments for the rotation of forces already employed on operations, as well as contingencies for operations specified by CJOPS, Lieutenant General Mark Evans, in his periodic forecasts.

Responsibility for generating long-term, generic capability and short-term specific capability would fall to two headquarters: HQ Forces Command would focus on the five-year plan, while HQ Readiness Command would focus on the one-year plan. In addition, HQ Readiness Command would:

- maintain the capability and capacity to deploy HQ JTF, tailored to particular operations
- be the exit point for land forces deploying on operations and the re-entry point for land forces redeploying from operations
- exercise technical control of deployed land forces to facilitate their sustainment and the dissemination of operational lessons to rotation forces

Readiness Command's new responsibilities and accountabilities would bring new authority and resources.³⁶ Adam Culley from AHQ completed much of the important preparatory work and resource management experts from LHQ and HQ Training Command redesigned resource management processes to accommodate the new structures. A Training Assessment and Force Preparation Group within Readiness Command would now have the authority and resources to certify and prepare land forces assigned from Forces Command.

Brigade commanders and their headquarters would concentrate on generic force preparation and no longer have responsibility for certification and specific preparation of land forces for ongoing and new operations. Thus, this new group, comprising an amalgamation of the existing CTC and the personnel preparation element of 39 PSB, would standardise certification and act as the mechanism for specific force preparation.

Symon proposed a five-step process for land forces making the transition from Forces Command to Readiness Command and onwards for joint employment:

- Step 1. Forces Command assigns land forces to Readiness Command with a comprehensive readiness report that specifies the start state (readiness level) prior to the conduct of mission training, assessment and certification
- Step 2. Readiness Command issues mission-specific equipment and mission-specific training equipment
- Step 3. The Training Assessment and Force Preparation Group delivers a special-to-mission training program for assigned land forces

³⁶ Accountability is defined by the ANAO as a process whereby organisations and individuals within them are responsible for their decisions and actions within a framework of appropriate scrutiny. It is achieved by having clearly defined roles through a robust structure. In the context of command and control, commanders are accountable up their chain of command for the performance of the organisation they command.

- Step 4. The Training Assessment and Force Preparation Group assesses the operational proficiency of assigned land forces
- Step 5. Readiness Command certifies and transfers land forces to CJOPS and HQ JOC at an agreed point (time and/or place) and an agreed start state (readiness level) for joint employment

While not specified, Symon presumably intended that the transition from joint employment back to Forces Command would involve HQ JOC delivering land forces at an agreed point, giving Readiness Command a start state report. Readiness Command would then divest returning land forces of their mission-specific equipment, debriefing them for lessons learned, and transferring them to Forces Command at an agreed point with an updated start state report. Brigadier Mick Moon, Chief of Staff, LHQ, would later clarify and refine the definitions of agreed points and start states.

While this paper emphasised the command and control mechanics of the force preparation and rotation process, it did not explain how logistic and administrative support for the process would be coordinated and delivered for the force generation process. Customised training and rehearsal, as well as issue of special-to-mission equipment, were obvious requirements. However the question remained: who and what organisations would be responsible and accountable for harnessing and delivering the resources for developing customised training, topping-up deploying forces with personnel and materiel, and providing an increase in garrison services where forces concentrated prior to sea and air deployment?

Red Team Review – 7 July 2008

Now that the workshops had refined the proposed models, the Red Team assembled at the Land Warfare Studies Centre at the Royal Military College, Duntroon, on 7 July. The team comprised officers with operational experience who had not participated in the preceding three workshops. They talked through each of the previous three workshops with Lieutenant Colonel Ryan and then reviewed the proposed options for new Army structures. The aim of the Red Team review was to:

- expose potential vulnerabilities in structures and procedures
- challenge accepted assumptions and solutions
- provide critical analysis in order to identify problems, address identified weaknesses and avoid surprises

This audit-like activity was a useful test of the outcomes of the 4D workshops. The following issues emerged:

- for the deployment rotation model to work, the Army would have to develop three homogenous (identical) brigades
- more explanation was required of the 'core skills' focus of Forces Command and 'mission-specific' focus of HQ 1st Division, as well as the links between HQ 1st Division, HQ JOC and other agencies such as the AFP and AusAID
- the command and control arrangements for the Ready Battalion Group (RBG) would be determined by how much additional training and administration was needed prior to certification
- more clarity was required on the management of the resources required for MRE, particularly for vehicles and major items of equipment

Symon and his staff met at the Land Warfare Studies Centre on 11 July to finalise their observations and recommendations. Once again participants discussed the rationale for change and then examined Model 1 and Model 2. This would be the final workshop before Major General Morrison convened a meeting of the other major generals to review and critique the proposed structures and processes that had emerged from the three 4D workshops and the Red Team review.

Generals' Day – 17 July 2008

Two days before a summit meeting of the Regular and Reserve major generals, Major General Mark Kelly and his staff at LHQ proposed two alternative models and Major General Ash Power and his staff at HQ Training Command proposed another. Kelly and Power felt that the two models developed in Canberra were not the only options and proposed their own for consideration at the Generals' Day.

The new models clearly had the potential to complicate and prolong the consideration process.³⁷ From Symon's perspective it would have been more helpful if representatives from both commands had made their contributions at the three workshops and the Red Team review.

Kelly's two proposed models were based on the view that he and his headquarters represented the best option to aggregate land force generation. Generic and specific force preparation had to be centralised under one headquarters. Under his first model two brigadiers would be responsible for collective and individual training respectively, with the brigadier responsible for collective training also tasked with specific force preparation. The other model disestablished HQ 1st Division completely and concentrated all collective training under LHQ in Sydney, leaving HQ Training Command to retain responsibility for the Army's individual training.

Power's model saw Land Command commanding all Regular Army units through a one-star deputy commander.³⁸ HQ 1st Division would have only 39 PSB under command and would also be the planning interface with HQ JOC. HQ Training Command would retain responsibility for individual training through its corps schools and other training establishments, and also command the 2nd Division with its Reserve brigades and units. The model was similar to the early Model 2 option developed at the first 4D workshop in May.

Thirteen of the Army's 22 Regular and Reserve major generals joined Lieutenant General Gillespie at Duntroon on 17 July 2008.³⁹ They reviewed and critiqued the models that emerged from the 4D workshops, as well as from LHQ and HQ Training Command. They then examined proposed command and control arrangements for a restructured Army and the new organisation of AHQ.

Once again, Major General Morrison and Brigadier Symon used three war games to test the models. The first used the 1996 Black Hawk disaster as a framework for discussion on matters of governance; the second examined the manpower implications of each model; and the third examined resource management issues. Major General Richard Wilson, Commander 1st Division, was a key participant and advocate for Model 1 that separated generic and specific force preparation. Though he may have expected HQ 1st Division to retain command of at least one high readiness brigade, he put the case for separation, while Major General Kelly advocated centralising both functions in Sydney under his command.

At the end of the workshop, participants voted on their preferred model. Their decision was to separate generic and specific force preparation and consolidate individual and collective training under one headquarters in Sydney. HQ 1st Division, with its three Regular brigades and a Training, Assessment and Force Preparation Group, would come under the direct command of CA for the time being.

37 Interview with Major General P.B. Symon, 22 April 2010.

38 One brigadier in Sydney would command five brigade commanders, as well as a brigadier in command of a planning and individual preparation headquarters in Brisbane called '1st Division'. HQ Training Command would retain corps schools and training establishments and gain HQ 2nd Division and its Reserve brigades and units.

39 Major Generals David Morrison, Paul Alexander, John Cantwell, Mike Crane, Mike Fairweather, Mark Kelly, Tim McOwan, Maurie McNarn, Ash Power, Mick Slater and Richard Wilson, as well as Major General the Honourable Justice R.R.S. Tracey.

Summary

The genesis of the Adaptive Army initiative from late 2007 until the Generals' Day on 17 July 2008 was a systematic investigation of options for change to enable the Army to better generate, prepare and certify land forces for joint employment while ensuring the most effective and transparent use of resources. The rationale for change was the need to:

- apply lessons from recent operational experience to streamline generic and specific force preparation
- align the Army with new joint ADF command and control arrangements
- anticipate future trends in warfare

The titular founding fathers were Lieutenant General Ken Gillespie and Major General David Morrison. Both had the necessary leadership and skills to initiate investigation, listen, learn, contribute, improve, influence and, ultimately, to direct change. The intellectual and philosophical founding fathers and change agents were Brigadier Paul Symon, Colonels Greg Bilton and Mike Tucker, and Lieutenant Colonel Mick Ryan at AHQ, supported by advice from senior Army commanders and staff officers.

Symon had formed the 4D compartment in February 2008. Behind the scenes, members of this 4D group debated and argued for hours over opportunities for enhancing the Army's command and control arrangements. They cared less for their worn rank and seniority and more for the expression of new, lateral ideas, fully aware that others in the group would carefully consider, test, and respect one another's ideas.⁴⁰ They represented the engine room for change, those who shaped the views of others and facilitated the essential consultative processes needed to distribute ownership of change and ensure its durability. They fought the intellectual battles in three 4D workshops conducted in May and June and in the Red Team and Generals' Day reviews in July.

The concept of a Forces Command that would be responsible for both individual and collective Army training received early support. This concept promised continuity and unity between the individual training base (schools and training establishments) and land force commanders who would receive trained individuals and return them periodically to the training base for further skilling.

The concept of a Readiness Command also received early support. Under this concept a major general and a capable headquarters would be responsible for reconnaissance, planning, establishing JTF headquarters and preparing assigned land forces for joint employment.

Lessons from operational experience over the previous decade showed that the preparation of assigned forces prior to deployment was a complex activity requiring the centralisation of responsibility, accountability, authority and resources. With rank comes authority. The appointment of a major general to demand and manage the resources required to rehearse deploying headquarters and force elements was a significant improvement on the ad hoc arrangements that had been forced on deploying commanders and their force elements, and on improvised contingents in the past.

The challenge for Commander 1st Division and his staff would be to summon and direct the logistic and garrison support resources from logisticians (JLC) and military base managers (DSG). Joint logistic units would have to coordinate the 'top-up' of assigned forces with materiel, including special-to-mission equipment and stocks, to achieve an operational viability period of independent supply until supply chains were established. DSG managers would have to summon contractor support for a surge in accommodation and garrison services to support the concentration of land forces and their 24/7 preparations.

40 Interview with Major General P.B. Symon, 22 April 2010.

Differences of opinion emerged over the rotation of higher readiness formations and units to and from Readiness Command and Forces Command. Theoretically, Readiness Command should command the Army's short-notice force projection capabilities – high readiness land forces postured for likely contingencies – as well as whatever brigade was providing rotation forces for ongoing operations. This approach would require annual changes in command and control of at least one brigade between Readiness Command and Forces Command.

Initially, there had been proposals for a two-month cycle for high readiness land forces prepared for short-notice contingencies, and an eight-month cycle for a brigade trained and postured for force projection. These aspirations foundered on disruptions to personnel management and other administrative difficulties.

The notion of a deployment cycle rotating brigades through operational employment to resting after deployment and then to preparing for the next employment was useful for establishing 'battle rhythm' and respite for families, but had no validity in the history of post-Cold War ADF operations. It was also unlikely that a ready brigade would have all the capabilities for expected and unforeseen contingencies, or the rotation of deployed forces that were based on corps capabilities such as medical, signals, engineer, armour and transport. The cycle also depended on each brigade of the Regular Army having very similar capabilities.

So, if there was no rotation of brigades, Forces Command would command the Regular and Reserve formations and units of the Army and only assign forces to Readiness Command for specific force preparation when the CDF assigned land forces to CJOPS, or CA assigned forces to Readiness Command in anticipation of a short-notice deployment. Readiness Command would be kept busy with the rotation of forces to and from ongoing operations, but it would not command a ready brigade each year.

The differences over rotation of high readiness formations and units between the two commands were not resolved by the end of the consultation and development phase in August 2008. In the interim, Lieutenant General Gillespie took command of HQ 1st Division and its regular brigades, leaving Land Command and Training Command to examine options for their amalgamation for the remainder of 2008. Gillespie was now ready to announce the Adaptive Army initiative and move to implement the required changes.

Articulating and Directing Change

Lieutenant General Ken Gillespie assumed command of the Army on 4 July 2008. He was appointed as a commander, trainer, preparer and 'reconstituter' of land forces. Lieutenant General Mark Evans, CJOPS, would deploy and employ assigned land forces on operations. Thus, Evans was responsible for ensuring that the Navy, Air Force and requisite contractors provided the sea and air lift that land forces required for deployment. He would depend on Major General Grant Cavenagh, CJLOG, for their offshore sustainment.

Gillespie had learned much in the previous two decades about the strengths and weaknesses of Army structures and processes for generating, preparing and projecting land forces for operations.¹ He had identified the need for a more systematic approach. He wanted to align the Army with the way that the ADF planned and conducted operations. Given the pre-eminence of CJOPS and HQ JOC, the Army had to change if it was to successfully meet the challenges of preparing land forces and collaborating with HQ JOC in order to optimise their joint employment.

The Army needed strong internal training, and administrative and logistic organisational 'muscle groups'. While these groups had to be aligned with enabling agencies on the one hand, they also needed the capability, capacity and adaptability to:

- shape joint plans to optimise land force deployment, employment and sustainment
- summon and coordinate the surge of training administration and logistic support required for specific force preparation in response to government decisions to take military action overseas, often at short notice
- contribute staff to joint task force and national headquarters
- facilitate timely reconnaissance with HQ JOC to inform specific force preparation

¹ Gillespie brought a breadth of contemporary operational, as well as command experience to the appointment. His first deployment overseas was as the second-in-command and operations officer for the second engineer contingent that served with the UN mission in Namibia in 1989–90, for which he received a Conspicuous Service Medal. He was Head Strategic Command Division in 2003 for Australia's participation in the invasion of Iraq. He commanded the UN Sector West multinational brigade in East Timor in 2000–2001, and he was the National Commander of Australia's contribution to allied operations in Afghanistan later in 2001, for which he received the Distinguished Service Cross and was advanced to Officer of the Order of Australia in the Military Division. On Australia Day 2011 he was advanced to Companion of the Order of Australia in the Military Division.

- acquire, store and issue special-to-mission clothing and personal equipment, as well as special-to-mission leading-edge technology
- rehearse deploying forces, contingents and headquarters for their operational roles during specific force preparation
- exercise technical control of deployed land forces and upgrade technology to enhance comparative advantage and competitiveness
- manage rotation of land forces in order to maintain operational tempo and comparative advantage and competitiveness
- contribute to the management of a joint supply chain to deployed land forces, particularly in spare parts and mail
- contribute to the establishment and management of contracts for goods and services in support of land operations
- conduct operational analysis to derive and disseminate lessons for immediate application to operations, and for incorporation of lessons into force rotation training, doctrine and Army capability development

In his first Order of the Day following his assumption of command, Gillespie emphasised that the Army must:

- continue to excel on operations
- remain capable, responsive and relevant now and into the future through the implementation of the Hardened and Networked Army and Enhanced Land Force initiatives²
- recruit and retain first class soldiers, officers and public servants³

He went on to declare his commitment to ensuring that the Army's structure was appropriate for current and future operational environments. He noted that the Army's multiple levels of command in a strict hierarchical structure reflected the pre-HQ JOC command and control arrangements. A great deal had changed since the 1970 Army Review Committee had created three functional commands.

Gillespie argued that the Army's system of command and control had to adapt to changes within the ADF over the past few years. There were too many headquarters slowing decision cycles, constricting the passage of information 'in an age of e-mail and Blackberries', and inhibiting the sharing of lessons learned. There were no commanders appointed with responsibilities, authority, accountability and resources for the Army's short, medium and longer term learning loops to and from operations. In addition, the information flows that maintained adaptability were disconnected from outside organisations such as the Defence Materiel Organisation (DMO), JLC and HQ JOC.

The new CA announced that he had commissioned a review of Army structures and processes for preparing and projecting land forces. He wanted the Army to deliver a broader range of land warfare capabilities in order to contribute more effectively to joint and inter-agency operations. The context of the reorganisation would be a natural and evolutionary process for the Army's continuous modernisation.

² The Enhanced Land Force initiative increased the size of the Army by two battalions, accompanied by facilities upgrades, and increased the size of the Bushmaster fleet to more than 400 vehicles. The total strength of the Army would rise to eight battalions — two mechanised, five light and one commando. Approximately 2600 additional personnel were to be recruited.

³ Lieutenant General K.J. Gillespie, 'Order of the Day on Assumption of Command for the Army', 8 July 2008, AWM: COL (OA) papers.

Articulating the Adaptive Army Initiative

Gillespie promised the CDF, Air Chief Marshal Angus Houston, and the Minister for Defence, Joel Fitzgibbon, that the Adaptive Army initiative would:

- improve the Army's alignment with, and capacity to inform, the ADF's strategic and operational joint planning
- better execute generic and specific force preparation in a manner that would balance operational commitments and contingency planning
- increase the effectiveness and efficiency of training within the Army
- improve the linkage between resource inputs and collective training outputs within the Army's force generation and preparation continuum
- improve the quality and timeliness of information flows throughout the Army in order to enhance adaptation mechanisms at all levels (ensure faster learning loops)⁴

Gillespie made his first public announcement at a conference convened by ASPI on 27 August 2008 at which he released a directive on the 'Adaptive Army'.⁵ He noted that the last time the Army had undertaken a wide-ranging re-examination of its structure and processes was in the early 1970s following the end of the Vietnam War. Times had changed. The twenty-first century Army was constantly projecting force regionally and internationally, often at short notice.

Both the preparation of personnel and organisations for operations and the projection of forces on deployment needed to be streamlined. The Army required a flexible force generation and preparation process, including an effective training system that could keep pace with rapidly evolving operational and contingency requirements for joint operations. These processes must align with the new joint command framework. Gillespie hoped that the closer alignment between HQ 1st Division and HQ JOC would improve planning and land force preparation processes, as well as establishing more rapid feedback of operational lessons into the Army's generic and specific force preparation cycles.

The centrepiece of the Adaptive Army initiative would be a consolidation of the Army's individual and collective training organisations into Forces Command (FORCOMD) – an amalgamation of Land Command and Training Command.

Directing Change

Gillespie envisaged a phased activity that would be conducted concurrently with the preparation of force elements for current operational commitments and contingencies. His timeline was ambitious, but he and his senior staff and those subordinate commanders who shared his drive for change were keen for change to be implemented before senior positions changed bringing a possible reversal of the Adaptive Army reorganisation.⁶ The phases would be:

- Phase 1. The restructure of AHQ into two divisions, beginning in February 2009. One division would focus on the Army's current activities (under the DCA) and the other would focus on the Army's force development and strategic planning (under a new Head Capability – Army). **Officer Responsible: DCA** ⁷

4 Ministerial Submission, 'The Adaptive Army Initiative', 4 August 2008; 'Adaptive Army: An Evolved Army Functional Command Structure', 4 August 2008, AWM: COL (OA) papers.

5 Directive 22/08, Lieutenant General K.J. Gillespie, 'Chief of Army Directive – 'Adaptive Army': The Evolution of Army's Higher Command and Control Structures', 27 August 2008, AWM: COL (OA) papers.

6 Annotations on penultimate draft, Lieutenant Colonel M. Ryan, 29 August 2010.

7 Major General Morrison would plan this phase with Brigadier Paul Symon in the second half of 2008. In February 2009 Symon would be promoted and appointed DCA.

- Phase 2. The restructure and re-rolling of HQ 1st Division to focus on the specific force preparation of Army force elements for current operations and contingencies, as well as its assignment to CJOPS for operational planning.⁸ The process would include raising a Training Assessment and Force Preparation Group [later renamed Land Combat Readiness Centre (LCRC)] that would incorporate the CTC and elements of 39 PSB. **Officer Responsible: COMD 1st Division**⁹
- Phase 3. In July 2009, the restructure of Land and Training Commands (less HQ 1st Division, 1st, 3rd and 7th Brigades and the Training Assessment and Force Preparation Group) into FORCOMD. **Officers Responsible: Commander Training Command, Major General Ash Power, supported by Commander Land Command, Major General Mark Kelly**¹⁰
- Phase 4. By January 2011, realignment of Army's processes and further restructuring to accommodate the implementation of an enhanced brigade rotation model through HQ 1st Division, with brigades not in the specific force preparation cycle residing within FORCOMD for reconstitution and generic force preparation. **Officer Responsible: COMD FORCOMD**¹¹

In order to streamline COMD FORCOMD's span of command over training establishments, Gillespie advised subsequently that he would centralise all officer and soldier entry-level training under the Commandant, Royal Military College (COMDT RMC), Brigadier Mick Moon. He also advised the establishment of a Combat Support and Intelligence, Surveillance, Target Acquisition and Reconnaissance (CS&ISTAR) Group in order to consolidate LHQ's direct command units. Initially, he had assigned another group of specialist units (military police, engineer project management and air-ground liaison) to Brigadier David Saul, Commander 17 CSS Brigade. He changed his mind after receiving further advice from Brigadier Saul and included them in the CS&ISTAR Group. Brigadier Jeff Sengelman would establish this group in the first six months of 2009 and take command on 1 July 2009.¹²

In 2008 Gillespie would rely on Major Generals David Morrison, DCA, Mark Kelly, the Land Commander, Richard Wilson, Commander 1st Division, and Ash Power, Commander Training Command, with the assistance of their senior staff, to think through and plan the changes that would be required.

In 2009, after refining and approving his plans for change, Gillespie would supervise implementation. Symon would restructure AHQ in his new appointment as DCA. Morrison would integrate and establish FORCOMD – the individual and collective training base that would maintain the Army's proficiency in foundation warfighting. Major General Mick Slater would take over from Wilson and restructure HQ 1st Division for specific force preparation. Newly posted Brigadier Jeff Sengelman would establish the CS&ISTAR Group, and new Command and Defence Staff College graduates Brigadiers Shane Caughey and Simone Wilkie would establish HQ FORCOMD by integrating the functions of LHQ and HQ Training Command.

Gillespie had articulated the reasons for change, what that change encapsulated, who would implement the change and when implementation would be completed. The Army was now entering a period of fundamental transformation. Over the next two years this initiative would change the way land forces trained, the way they prepared to fight, and the way they deployed and sustained themselves away from home bases.

8 The title 'Readiness Command' had been dropped. This was partly to do with not losing the historical title '1st Division' from the Army's Order of Battle (interview with Major General D.L. Morrison, 3 December 2009) and partly to signify that the organisation was totally dedicated to specific force preparation and would only have units under command for that purpose.

9 Major General Richard Wilson would complete the planning in 2008 before handing over to his successor, Major General Michael Slater, in 2009 for implementation.

10 Major General Morrison would become the Land Commander in December 2008 when Kelly assumed national command of ADF forces in the Middle East.

11 Major General David Morrison would assume command of FORCOMD on 1 July 2009.

12 6 ESR, 19 CE Works, 1 Int Bn, 20 STA, 16 AD Regt, 7 Sig Regt, 51 FNQR, NORFORCE, Pilbara Regt, 2/30 Trg Gp and 1 GL Gp.

Getting Training Right – Generic Force Preparation

In line with foreshadowed strategic guidance, the first priority for the Army in 2009 and thereafter would be to train land forces for conventional combat against forces threatening Australia and its territories. The second priority would be to train for stabilisation operations in the immediate neighbourhood, the Asia-Pacific region and globally. Concurrently, the Army would need to maintain specified land forces on high readiness in anticipation of national, regional and international emergencies.

Adaptive Campaigning reflected these strategic imperatives. Joint combat was first and most important, followed by four lines of operation focused on interacting with and influencing the population and defeating hostile groups in an area of operations.

One of the most important goals of the Adaptive Army initiative was to strengthen training. The Army had to have an efficient system for the provision of individual and collective training. Since the early 1970s Training Command had designed, developed, delivered and evaluated individual training, in consultation with technical training advisers from the various corps, and managed the corps and non-corps training establishments. Since 1987 LHQ had managed collective training in order to prepare combat-ready land forces for joint employment.

The establishment of FORCOMD would amalgamate Land and Training Command. One major general would be given responsibility, accountability, authority and resources to identify new and continuing training needs and priorities, in conjunction with CA, and then design, develop, conduct and evaluate both individual and collective training in a continuum. The challenge would be to blend the competence of Training Command and Land Command in individual and collective training into an Army Training Continuum (ATC) that integrated and synchronised both training systems to prepare land forces for joint employment.

Designing Headquarters Forces Command

In August 2008, Major General Ash Power, Commander Training Command, and his staff began exploring options for amalgamating LHQ and HQ Training Command, in conjunction with Major General Mark Kelly, the Land Commander, and his staff. By this time AHQ had completed a series of workshops that refined two models for the organisation of the Army (see Chapter 2).

Power set a timetable of six phases that would lead to his presenting his findings on 28 November 2008 to allow Lieutenant General Gillespie to decide on the final organisation of HQ FORCOMD. In late October, designated staff at LHQ and HQ Training Command would conduct an internal review of functions, activities and definitions in order to identify and analyse several options. They would then conduct a detailed options analysis and a war-gaming exercise that would test the advantages and disadvantages of each option.¹

Power defined the FORCOMD mission as 'generating the Army's Foundation Warfighting capability in order to ensure individuals and land forces would be successful in adaptive campaigning.'² This comprised five lines of operation:

- **joint land combat:** actions to defeat organised resistance and secure the environment in order to set and sustain the conditions required for the other lines of operation
- **population protection:** actions to provide protection and security to threatened populations in order to set the conditions to establish order and the rule of law
- **information actions:** actions that inform and shape the perceptions, attitudes, behaviour and understanding of target population groups and assure the quality of ADF information while attempting to disrupt and dislocate command capabilities of hostile groups
- **population support:** actions to relieve immediate human suffering by establishing, restoring, or temporarily replacing necessary essential services in affected communities
- **indigenous capacity building:** actions to nurture the establishment of capacity within civil communities, while simultaneously working to establish long-term governance and social economic capacity to meet people's needs³

The new integrated headquarters had to possess the ability to interact with HQ 1st Division, HQ SOCOMD and HQ JOC while concurrently:

- conducting individual and collective training
- contributing to capability development
- generating land forces at readiness (start states)

Power wanted HQ FORCOMD to have a streamlined, sustainable and robust command and control structure that made it 'commandable', 'understandable' and adaptable.⁴ In order to achieve this there had to be:

- appropriate spans of command and delegation of command
- clear delineation of responsibilities
- a simple chain of command
- staff capability to plan across all functional areas, such as individual and collective training, as well as force generation

His approach was to harness the qualifications and experience of staff who would follow a step-by-step process. The first step was to identify the tasks required of the new HQ FORCOMD. An internal review at the end of October produced an extensive list of tasks (see Figure 9).

1 Blue Team: COFS LHQ and colonels from TC-A and LHQ. Tasks: to respond to problems at HQ FORCOMD and direct activity and responses. Red Team: TC-A/LHQ Adaptive Army Planning Team. Tasks: introduce problems and issues to the Blue Team and update and develop problems, and record strengths and weaknesses of structural options.

2 PowerPoint Presentation, Major General B.A. Power, 'HQ FORCOMD and CS Bde Development COA Decision Brief', 28 November, AWM: Col (OA) papers.

3 Australian Army, Head Modernisation and Strategic Planning – Army, Army's Future Land Operating Concept, Australian Army Headquarters, Canberra, 2009, Chapter 4.

4 Power, 'HQ FORCOMD and CS Bde Development COA Decision Brief'.

Figure 9 Tasks for Forces Command

Function	Tasks	Tasks
Command	Command of assigned formations: (Up to 3 manoeuvre brigades, 16 Avn Bde, 17 CSS Bde , Modularised Engineer Force (MEF), Combat Support and Intelligence, Surveillance, Target Acquisition and Reconnaissance (CS &ISTAR) Bde, 2 Div, All Corps Training Group and Land Training Group	Maintenance of Registered Training Organisation status and act as Executive Training Authority Maintain links with AHQ, 1 Div and SOCOMD and other stakeholders as well as with Head Capability Development-Army (HCD-A) for the recruitment, retention of all Army personnel
Plans	Vertical Slice planning staff/advice supplementation to AHQ and 1 Div for operations, including provision of specialist advisers to 1 Div, AHQ and SOCOMD Planning for : Individual and collective training, capability, mobilisation,	International Engagement programming schedule Army In Being/future force Unit Establishment reviews and liability planning
Analysis and Development	Individual and Collective Training Force Modernisation Establish Medium Learning Loop/Lessons Identified Operational analysis, simulation Training and education strategy	Trg Standards, levels and evaluation, including career and trade management, curriculum review boards Force Generation Facilities, Infrastructure, Scientific advice, OT&E, experimentation
Operations	Force Generation for JOC/1st Division Generation of operational deployments outside 1st Division Regional Forces Surveillance Units, 2nd Division/OP ANODE [Solomon Islands], Ready Response Forces Execution of International Engagement program	Delivery of individual and collective Foundation Warfighting Training Support to force generation and training Evaluation of individual and collective training Overseas Training and Education
Personnel, Logistics and Comms	Trade management, postings, TACOS, Honours & Awards Policy, investment in people, retention, people initiatives Personnel management and plan Administration and welfare Corporate support agreements and management Material policy, management and sustainment	Introduction into service/disposal Fleet management Equipment maintenance and fleet inspections Technical control of CIS units/capabilities/ information management within FORCOMD Business Plan/Resource planning/Corporate governance Corporate support agreements and management Material policy, management and sustainment Introduction into service /disposal
Infrastructure /Real Estate Management	FORCOMD communications support RAP Asset management	DSG Barracks infrastructure Security
Training and Resource Management	Capability information management Management of the FORCOMD TARP strategy and processes Resource and training requirements Readiness performance and resource usage	Army Capability Management System Contract management Intellectual property management and protection

This process of blending tasks was important. Training Command was a business unit which managed resources, planned activities, received trainees, conducted and evaluated training and delivered trained personnel. While there were distributed learning programs, the bulk of training was conducted face-to-face on residential courses at training establishments. The command and control focus at HQ Training Command was on management of resources and training throughput. The command and control focus at LHQ was on achieving and maintaining prescribed levels of readiness for land forces for joint employment. While HQ Training Command remained in touch with doctrine to guide its training, Land Command focused on contemporary operations and adapting training to those operations and to doctrine. Thus, one headquarters was systematic and procedural, and the other was pragmatic and mission-oriented.

The challenge for Power and his Adaptive Army implementation team was to comprehend the differences and accommodate them to achieve the command, planning, force preparation and sustainment tasks to support individual and collective training. There would be industrial issues among Australian Public Service (APS) staff, as well as financial and resource management issues, but these could be resolved through practised processes. More challenging would be selecting, validating and establishing the right structure for planning, and conducting and sustaining training operations before 1 July 2009, HQ FORCOMD's first day at work.

Power presented two options for Gillespie's approval on 28 November. In the meantime, Gillespie had changed his mind about which headquarters should command the Regular brigades. He selected the model that gave HQ FORCOMD command of all the Army's brigades and training establishments, as well as a number of specialist units grouped in a CS&ISTAR Group – a 3000-strong organisation of 11 specialist units that would be managed by a brigadier at HQ FORCOMD. This amalgam of specialist units would be assigned to support collective training and operations. Power envisaged the CS&ISTAR Group generating and deploying joint and specialist capabilities for operations, as well as managing their long-term capability development with emphasis on joint effects such as target acquisition, information operations, intelligence, electronic warfare and surveillance.

Thus, HQ FORCOMD would have two Regular brigadiers at Victoria Barracks in Sydney working directly to COMD FORCOMD. One would be the Chief of Staff for the entire command, a continuation of the Chief of Staff position at LHQ. The Director General Training (DGT) would manage training through Operations Branch (G3) and a Training and Education Branch (G7). Operations Branch would direct force generation (generic force preparation)⁵ and Training and Education Branch would plan collective and individual training courses and activities.

In addition to four consolidated training groups⁶, an enhanced implementing headquarters at RMC, Duntroon, would command:

- the Royal Military College of Australia (RMC-A), located in Canberra
- ARTC at Kapooka
- the Headquarters Regional Training Centres at Canungra (all-corps training for senior NCOs and warrant officers)
- Combined Arms Training Centre at Puckapunyal

Thus, COMDT RMC would report to COMD FORCOMD through DGT for entry and intermediate-level officer and soldier training. Senior management training for Army officers would continue at the Australian Defence College located in Canberra, under the VCDF, Lieutenant General David Hurley.

⁵ Prepare land forces and contingents to the agreed start state for handover at the agreed point for HQ 1st Division to begin specific force preparation for transition to higher readiness for contingencies or for deployment under HQ JOC arrangements.

⁶ Army Aviation Training Centre (AAVNTC), Army Logistic Training Centre (ALTC), Combat Arms Training Centre (CATC) and Defence Command Support Training Centre [DCSTC, DFSS, DFSM, Defence Police Training Centre (DPTC), DFSL and DIntTC].

Figure 10 Outline Organisation for HQ FORCOMD – November 2008

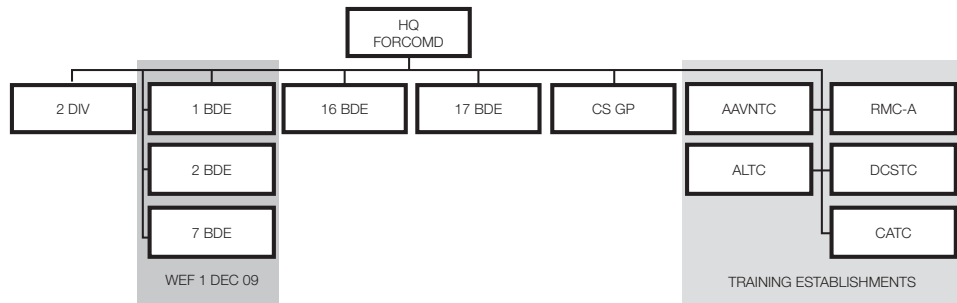
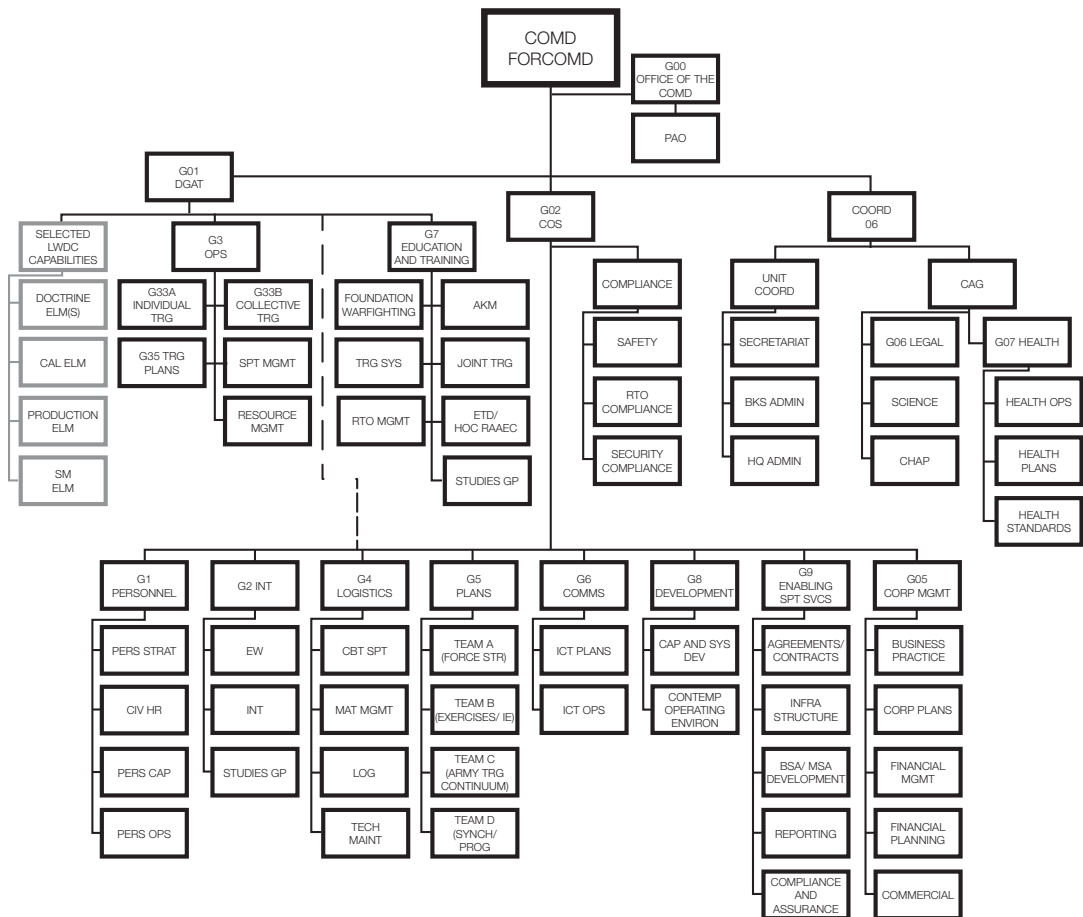

Figure 11 Detailed Organisation of HQ FORCOMD – November 2008



Transfer of Responsibilities

On 3 December 2008, Lieutenant General Gillespie assumed direct command of 1st Division from Land Command. From that day, LHQ began handing over operational planning responsibilities with HQ JOC to HQ 1st Division and transferring the management of minor operations and prescribed activities to HQ JOC. LHQ continued to plan force generation with AHQ.

These changes simplified and strengthened the Army's planning processes for both generic and specific force preparation. Gillespie could now pass the CDF's strategic guidance directly to Major General Mick Slater, Wilson's successor as Commander 1st Division, who in turn had responsibility, accountability, authority and resources to contribute directly to joint planning at HQ JOC. Slater would await force assignment and the arrival of land forces and contingents at an agreed point (place and/or time) at agreed start states (readiness levels) from Major General Morrison so that LCRC could begin specific force preparation.

From 3 December 2008, Slater became responsible and accountable to Gillespie for specific force preparation including concentration, MST, MRE and certification, as well as RSO&I for land forces, *ad hoc* contingents and individuals redeploying from operations as part of the rotation cycle.

Designing the Army Training Continuum

Major General Power articulated the strategic direction for individual training in December 2008 before handing over command to Major General Mike Hindmarsh, who was returning from service in the Middle East. Hindmarsh would assist with the development of the ATC and transition to FORCOMD over the coming six months prior to his retirement.⁷ Power asserted that, if twenty-first century soldiers were to fight and win against an adaptable enemy, they had to be supported by an adaptable army – one that routinely internalised its lessons and learned as fast as its soldiers serving at the cutting edge of operations. He envisaged a learning army that would remain in a continuous state of adaptation and improvement, supported by an optimal learning culture and underpinned by processes and technologies that would deliver up-to-the-minute learning and development at times and places to suit learners and the Army.

Mindful of increasingly complex Information Age operations, Power specified three principles to guide Army training:

- professional mastery
- adaptive action
- shared values and mutual obligations

He defined professional mastery and its accompanying principles as:

- an amalgam of the ability of commanders and soldiers, trainers and trainees to execute their duties in an environment of shared values and common goals
- the ability to perform duties in a range of circumstances and adapt quickly to changes in those circumstances
- the self-confidence to act autonomously and decisively despite risk and ambiguity
- an understanding of the purpose and consequences of their actions for a range of changing circumstances
- the physical, intellectual and moral exertion to overcome fear, confusion, fatigue and uncertainty

⁷ Directive, Major General B.A. Power, 'Commander's Guidance: TC-A Strategic Direction', X1127917, HQ TC-A, 2 December 2008, AWM: COL (OA) papers.

Power envisaged the Army following these principles through a number of lines of development that he commended to those commanders and instructors responsible for managing the ATC. He called for more self-directed, values-based and experience-based learning that would lead to increased capacity to adapt and encouragement of divergent and independent thinking and learning, thus maximising the intellectual and moral components of the Army's fighting power. While encouraging instructor development, he highlighted the advantages of training technology, such as modularised and distributed learning, blended learning strategies, single-entry portal learning and knowledge management systems.

Lieutenant General Gillespie had directed Major General Morrison to develop the ATC when he first articulated the Adaptive Army initiative at the end of August 2008 when Morrison was DCA. After consultation with his commanders and staff in Canberra, and with Power and several of his commanders and senior staff in Sydney, Morrison, the newly appointed Land Commander, issued a draft Army Training Policy in February 2009.⁸

Inputs to the Army Training Continuum

There were four inputs that shaped the ATC. The first was the Army's Continuing Learning Process (ACLP). The 2005 Army Capability Requirement and Learning Culture Inquiry recommendations had led to the conceptualisation of an Army learning organisation which was being implemented through the ACLP.⁹ This new learning process focused on:

- understanding learners
- fostering Army values and behaviours
- improving the balance between training and education
- exploiting technology
- developing instructors
- linking individual, collective and operational learning
- improving organisational learning and measuring learning achievement
- focusing structures to generate forces for joint employment
- marketing the learning Army

The new Adaptive Campaigning doctrine gave the ATC its operational context. Three of the five lines of operation underpinning this doctrine involved supporting and protecting populations and developing local military capabilities. The challenge for the ATC would be to integrate the demands of the other lines of operation – joint combat operations and information actions – with these three lines.

Adaptive Campaigning doctrine moved the Army's planning paradigm from a 'force-on-force' contest to one that accommodated the more complex and diffuse problems likely to be encountered during stabilisation operations. It also encompassed the traditional military search for asymmetry: pitting strengths against an adversary's weaknesses while guarding weakness from an adversary's strengths.¹⁰

8 Major General D.L. Morrison, 'The Army Training Continuum', LHQ/OUT/2009/X1194355, Land Headquarters, c. June 2009, AWM: Col (OA) papers.

9 The CDF, Air Chief Marshal Angus Houston, commissioned the Learning Culture Inquiry in February 2006 in response to the Senate Committee report into the effectiveness of Australia's Military Justice system that identified aspects of ADF culture as a possible cause of shortfalls in that system.

10 Head Modernisation and Strategic Planning – *Army, Army's Future Land Operating Concept*, Chapter 4; US Army TRADOC is exploring a new Commander's Appreciation and Campaign Design concept. Pamphlet 525-5-500 *The US Army Commander's Appreciation and Campaign Design*, US Army Training and Doctrine Command (TRADOC), 28 January 2008.

In particular, Adaptive Campaigning recognised the centrality of the attitudes and circumstances of the local population to success. Combat operations and the destruction of an opponent's military capability were only setting the scene for the restoration of populations to pre-conflict normalcy. Clearly, civil-military collaboration would be critical to population protection and support, as well as indigenous capacity building.

The adaptation cycle was an important input.¹¹ It underpinned leadership through shared understanding and autonomy of action. The adaptation cycle was founded on the concept of a perpetual decision-making loop:

- sense (learn to see and measure what is important)
- decide (understand what the response means and what should be done)
- adapt (learn how to learn, know when to change and challenge understanding)
- act (discovery actions and decisive actions)

The final concept that informed the ATC was the Human Dimension¹². This concept focused on four areas:

- cultural competence and capability – understanding of complex social, cultural, historical, political, economic and population geography within an area of operations, demonstrating an appropriate degree of empathy and engagement with the population, as well as having basic cultural, social and language skills and specific-to-country knowledge
- ethics and morality – every soldier is an expert in close combat, a leader, physically tough, mentally prepared, committed to continuous learning and self-development, courageous, takes the initiative, works for the team, and demonstrates compassion
- complex decision-making
- networking – increasing speed of communications, leveraging social media and culture change (delegation down the chain of command for communicating the dominant narrative)

The Human Dimension consists of four dimensions:

- executive management (policy, procedures, enterprise systems, enabling support, organisation and resources)
- knowledge management (a combination of people, processes and technology that enables the Army to create, validate, manage, distribute and update knowledge derived from the short, medium and long learning loops)
- learning and assessment (the acquisition and application of new knowledge, skills and attitudes to produce a positive and permanent change in behaviour)
- information and communications technology (ICT) (enabling functions such as executive management and enterprise systems, information environments, knowledge storage, and computer-based learning and simulation)

Another input was the competency-based Defence Training Model (DTM). The ATC blended the strengths and accountability of the DTM and its accompanying regulatory environment with the responsibilities and accountabilities of commanders. It synchronised individual and collective training with the preparation of brigades for operations and the return of forces from operations in order to clarify priorities of effort and resource allocation, while firmly connecting training to operational

¹¹ See Head Modernisation and Strategic Planning – *Army, Army's Future Land Operating Concept*, Chapter 4.

¹² Ibid. See also Pamphlet 525-3-7 *The US Army Concept for the Human Dimension in Full Spectrum Operations 2015-2024*, US TRADOC, 11 June 2008; Pamphlet 525-3-7-01 *The US Army Study of the Human Dimension in the Future 2015-2024*, US TRADOC, 1 April 2008.

performance. The emphasis on evaluation, as well as the identification and application of lessons, incorporated Gillespie's intentions for the Adaptive Army initiative to set higher standards, embed continuous improvement and increase the relevance of training to strategic guidance, as well as contemporary operations and contingencies.

Morrison envisaged the ATC as what he called 'a single, fused and holistic training model' that would cover the training of individuals through to the deployment of land forces at a high standard of collective capability. He asserted that it would be an operationally focused, sustainable and progressive system that would enable the conduct of realistic and challenging training that fostered the appropriate risk awareness ethos vital for success on operations.

Structure of the Army Training Continuum

The ATC would commence with *Ab Initio* (entry-level) training and progress through individual and collective training and force preparation to produce forces capable of conducting operations proficiently and successfully. Training would encompass a combination of tasks conducted to standards, levels, conditions and frequency comprising the following progression:

- **Ab Initio training** – initial basic military training
- **individual training** – training, education and development to provide officers and soldiers with the skills, knowledge and attitudes to enable them to take their place in a team
- **collective training** – training of one or more crews or detachments, sub-units, units and formations in the conduct of tactical operations. This training comprises five elements:
 1. **Foundation Warfighting training:** fundamental individual and essential core collective training that underpins operational capability and readiness to enable force elements to successfully conduct the full spectrum of sustained operations required for adaptive campaigning
 2. **MST:** training for directed tasks that delivers the particular knowledge, skills and attitudes to prepare individuals, teams or task forces to deploy on operations in a specific theatre, role or environment that is shaped by the mission, environment, lessons and threat
 3. **MRE:** realistic, relevant and demanding training exercises that deliver cohesive and sustainable forces, thoroughly prepared, rehearsed and capable of executing all expected operational tasks
 4. **deployment training:** training conducted on ships in transit to an area of operations or at staging bases following pre-positioning in anticipation of entry into theatre
 5. **in-theatre training:** training conducted during RSO&I following arrival in theatre to update MRE or following initial employment in order to create or develop skills required for an evolving mission; to refresh troops at intervals throughout the tour; and to rehearse different combinations of teams, sub-units and units

Contemporary Operating Environment

Importantly, Morrison clarified the training context by describing a contemporary operating environment (COE) influenced by military, political, psychological and economic factors. The COE would be characterised by the prevalence of:

- non-state actors
- increasing domestic and international scrutiny and accountability
- integration of military effort into whole-of-government responses to national, regional and international events
- terrorism

- both high and low technology asymmetry
- operations 'among the people'¹³ and in the presence of the media

Morrison envisaged FORCOMD developing a general scenario for training based on the generic context of a COE with the following features:

- a physical environment in relatively undeveloped countries, characterised by large spaces with significant natural obstacles and poor or limited infrastructure that would impose major logistic, communications, mobility and other technical challenges
- hostile forces that would choose to fight in complex terrain, particularly urban, but also jungle/close country and desert/arid areas in order to limit the ADF's manoeuvre (armoured fighting vehicles, helicopters) and weapons platforms (air and artillery precision fires), and intelligence, surveillance, target acquisition, and reconnaissance (ISTAR) capabilities
- a political environment characterised by multinational involvement and coalition operations, as well as a requirement to maintain reputation by minimising own and civilian casualties and damage to the local infrastructure and economy
- a human environment characterised by ADF forces having to interact with local populations, many of whom may be displaced, destitute and traumatised, possibly with languages, cultures and values unfamiliar to most ADF personnel
- a range of both government and non-government humanitarian aid agencies and local and international organisations competing for local resources and possibly seeking protection and emergency logistic support
- a legal environment characterised by intense legal, political and media scrutiny of the actions of ADF forces, particularly in the application of lethal force, detention, own and civilian casualties and ethical conduct
- a commercial environment in which national and international contractors would compete for the provision of goods and services, including security services that would complicate the identification of friend and foe
- a military environment characterised by a wide range of military factions and circumstances

This description of the contemporary military environment brought Army thinking into the twenty-first century. Opposing forces were characterised as extremely competent, well-equipped and capable of combined arms operations. Army training would anticipate opponents being supported by close air support, attack helicopters, unmanned aerial vehicles (UAV) and ISTAR capabilities, as well as chemical,¹⁴ biological,¹⁵ radiological¹⁶ and nuclear (CBRN) capabilities and improvised explosive devices (IED).¹⁷

While anticipating well-trained and equipped opposing forces and hostile groups capable of joint combat, the COE also anticipated irregular opponents, such as guerrilla forces and insurgents operating 'among the people' either during or after conventional operations, who would launch

13 Rupert Smith, *The Utility of Force: The Art of War in the Modern World*, Penguin Books Ltd, London, 2005, pp. 17–18.

14 Chemical weapons are often divided in five categories: nerve agents, blister agents, choking agents, blood agents and incapacitating agents.

15 Biological weapons are weapons of organic nature such as bacteria and viruses, including toxins produced by organisms.

16 Two types of radiological weapons exist. The first is a radiological dispersion device also known as the 'dirty bomb'. This is a weapon in which an explosive charge is combined with radiological materials instead of (or in combination with) pieces of shrapnel. The second type is a silent radiator; this is a weapon that emits radiation while concealed in a public place to radiate as many people as possible or a certain group of people.

17 A device placed or fabricated in an improvised manner incorporating destructive, lethal, noxious, pyrotechnic, or incendiary chemicals, and designed to destroy, incapacitate, harass, or distract. It may incorporate military stores, but is normally constructed from non-military components.

media campaigns to undermine public support for ADF operations.¹⁸ This would necessitate sensitive and precise targeting and compliance with Rules of Engagement.

Morrison eschewed 'top-down' prescriptions to prescribe what forces required to complete Foundation Warfighting training. He defined essential collective capabilities as offensive and defensive operations, as well as manoeuvre and movement through the battlespace, including crossing complex obstacles at all levels, and road movement in the combat zone. All Army exercise scenarios would present a context at least two levels up; i.e. units were to train in a brigade and divisional context, and brigades in a corps context.

Land forces would train to create both kinetic (apply lethal force) and non-kinetic effects (coercion and encouragement through deterrent presence) related to influencing the attitudes and circumstances of the population and hostile groups. Kinetic training would focus on integrating air, aviation, UAV, ISTAR and land force capabilities for fighting, targeting and striking opposing forces, including time-sensitive targeting. Fire support teams would direct and coordinate joint fires (artillery, mortars, aviation, and naval gunfire or service aircraft) and effects.¹⁹ Non-kinetic training would focus on civil-military cooperation (CIMIC), psychological operations (PSYOPS), information operations (IO), public relations (PR) and electronic warfare (EW).

Effects-based Structures

An evolving effects-based approach to Foundation Warfighting would supplement traditional 'force-on-force' campaigns, battles and engagements related to the operational art. These effects would focus on influencing populations and hostile groups. Morrison sought better inter-service (joint) and inter-agency collaboration. Land forces would be trained not only to fight opposing forces with weapon systems, but also influence their behaviour and capabilities through carefully planned and calibrated 'non-kinetic' effects such as creating positive attitudes among the population that would enhance the protection of Australian land forces and increase the flow of human intelligence – 'soft power' complementing 'hard power'.²⁰ These effects would often involve collaboration with coalition partners, NGOs and other national and international organisations.

While not explicitly stated, Morrison was also suggesting that the ad hoc joint task force structures of the past would be replaced by a concept similar to the US Army's modular structures. In other words, force elements from all three services, and possibly other government agencies, would be organised, trained and rehearsed (specific force preparation) for deployment for particular contingencies. For example, an inter-agency task force would be trained to conduct whole-of-government responses to natural disasters in the near region. This task force would deploy to devastated areas where immediate communications and logistic support for deployed Australian organisations and humanitarian support for the local populace would be important effects.

18 See John H. Holland, *Hidden Order: How Adaptation Builds Complexity*, Addison-Wesley Publication Company, New York, 1995.

19 Effect: 1. the physical and/or behavioural state of a system that results from an action, a set of actions, or another effect. 2. A change to a condition, behaviour, or degree of freedom. A desired effect represents a condition for achieving an associated strategic or operational objective, while an undesired effect could inhibit progress toward the same objective. See US Armed Forces, *Commander's Handbook for an Effects-Based Approach to Joint Operations*, US Joint Forces Command, 24 February 2006.

20 See Joseph Nye, *The Paradox of American Power, Why the World's Only Superpower Can't Go It Alone*, Oxford University Press, New York, 2002; *Soft Power: The Means to Success in World Politics*, Public Affairs Books, New York, 2004; *Understanding International Conflicts: An Introduction to Theory and History* (7th edn), Longman Classics in Political Science, New York, 2009.

Land Force Projection

Guided by the forthcoming 2009 Defence White Paper, Morrison set the benchmarks for self-reliant projection of Australian land forces overseas. Army training would focus on the maintenance of high-end warfighting skills that would culminate in a deployable Australian-led combined task force, based on a brigade group and enabling logistic support, optimised for sustained close combat and able to operate offshore in a joint and coalition environment.

Foundation Warfighting training would be the bedrock from which the Army would adapt to meet contemporary operational requirements. He acknowledged that maintaining the spectrum of Foundation Warfighting skills would be very demanding, but would enable Australian forces to operate more effectively along the lines of operation specified in Adaptive Campaigning. In other words, the Army would train for high-intensity warfighting and be able to adapt and conduct stabilisation and other types of operations for predicted and unforeseen urgent contingency operations. Army training would be based on a 'train as you fight' approach that would adapt Foundation Warfighting skills to the COE in the Asia-Pacific region and globally.

Force Generation Cycle

The ATC would streamline the Army for rapid, strong and smart short-notice deployment, as well as force rotation to maintain operational tempo and proficiency. It would synchronise with what Morrison called 'a force generation cycle' that would enable forces to be at the highest appropriate state of training (start state), prior to being assigned to HQ 1st Division for specific force preparation. Within a two-year training cycle,²¹ Morrison envisaged FORCOMD preparing and maintaining forces at readiness and subsequently reconstituting them in three broad phases²²:

- **Phase 1 – Reset Phase.** The Reset Phase would focus on leave, attendance at career, promotion and individual training courses, and enhancing retention through encouragement of personal development and family life. Logistic reconstitution, such as remediation, issue and replacement of equipment and materiel, would also be important. Some equipment might need to be issued while forces were deployed or at readiness in order to maximise preparation during the Reset Phase.
- **Phase 2 – Readying Phase.** The main effort for the Readying Phase would be on the development of the Army's combined arms capability from team/section up to battlegroup within a formation context (live and virtual). This would enable each brigade to conduct a combined arms training activity and a battlegroup-level exercise with all supporting arms and services prior to MST.²³ While individual training would continue during this phase, the priority would be collective training up to and including major warfighting exercises, MST, MRE and certification of force elements for operations, or at readiness. On completion of Foundation Warfighting training, those units warned for operations would be force assigned to HQ 1st Division to conduct MST appropriate to their role or deployment. A nominated brigade would support MST and MRE for deploying forces and contingents.
- **Phase 3 – Ready Phase.** The main effort for the Ready Phase would be ensuring that collective skills were maintained at the required levels for operations. In this phase, forces would be allocated to CJOPS for deployment or maintained at readiness in FORCOMD for contingency operations. They would be at their highest level of training. The CA would assign FORCOMD forces to CJOPS for operations and contingencies as directed by the CDF. Once they had completed specific force preparation with HQ 1st Division, assigned forces would transfer to CJOPS at an agreed point and he and HQ JOC would be responsible for their deployment and tasking. However HQ FORCOMD

21 The force generation cycles for the 2nd Division, 16 Avn Bde, 17 CSS Bde and other specialist units would align with this concept, but on a one-year rotation.

22 Readiness is the time required for elements of a force to be ready to deploy for operations from their home base or current location, appropriately manned, equipped, trained and supported.

23 MST delivers the specific skill sets, building on the foundation warfighting training, that equip the individual, team, unit or formation to deploy on operations in a specific theatre, role or environment or to be an earmarked reserve.

would remain engaged with deployed forces, through HQ 1st Division, to ensure that rotation training remained relevant and appropriate. This connection through HQ 1st Division would also enable HQ FORCOMD to ensure that Reset (reconstitution) on return from operations was efficient and effective.

Forces that had not deployed from on-line formations in the Ready Phase would support the training conducted by units in the Readying Phase. As these units would have recently completed Foundation Warfighting training and MST, they would have reached a high standard of training. They would be well suited to provide support to LCRC, to deliver collective training, MRE and other programmed training activities. Commanders at all levels would also continue individual and collective continuation training while they were either at readiness or deployed in order to maintain core skills and ensure forces remained busy and focused.

While there would be changes to the detail of each training year, Morrison clarified that some predictability and alignment was important to allow formations to 'grow' a collective capability through defined training steps. The force generation cycle was designed to maximise this approach and it would underpin all training, noting that:

- the cycle was a flexible and consistent model that could be adjusted to reflect increased tempo or scaled back if commitments reduced
- there would, inevitably, be some overlap between the three phases and, therefore, commanders should train their subordinates to operate at least 'one up', so that they could step up when required, something that should be regarded as 'normal business'

Deployment and In-theatre Training

The ATC also included training that would occur during and after deployment. This was important because ADF doctrine did not specify the conduct of this training and, as a result, in the past it had occurred on an improvised ad hoc basis in support of operations. Typically this training would occur during RSO&I following arrival in theatre. Sometimes training would be conducted on ships in transit to an area of operations.

Morrison suggested that CJOPS nominate Australian national commanders to take responsibility for contingent training. He added that CJOPS might also nominate Australian Combined Joint Task Force (CJTf) commanders to assume responsibility for training land forces as they left the agreed point and commenced deployment under direction of CJOPS and HQ JOC.

This 'top-up' training during deployment and before employment would be delivered in theatre, in transit or in forward mounting bases. RSO&I would include a mix of training and orientation activities. Typically, this would involve:

- revision of key MST skills
- theatre tactics techniques and procedures (TTP) updates
- familiarisation with rapid acquisition/mission-specific equipment not available in the home base
- zeroing/calibrating weapon systems from storage or transit
- fitness training to aid acclimatisation

Morrison expected CJOPS/CJTf to be responsible for in-theatre training that would:

- create or develop skills required for an evolving mission
- conduct updated mission rehearsal
- refresh troops at intervals throughout the tour
- rehearse different combinations of teams, sub-units and units

International Engagement and Joint Exercises

Interoperability with allies and coalition partners will always be an important element of Army preparedness and combat effectiveness. Morrison emphasised that international engagement would continue to be a fundamental part of Foundation Warfighting training and that the training conducted with allies and coalition partners would be aligned with the ATC and the force generation cycle in order to maximise training opportunities and minimise personnel turbulence/over-training. High profile major multilateral and bilateral exercises, such as Exercise Talisman Sabre, would require detailed planning to ensure that they maximised training opportunities.

The annual FORCOMD major activity and exercise program, including international engagement exercises, would now comply with both the force generation cycle and the ATC. All exercises would be coordinated and incorporated into a progressive training program that would relate to relevant training levels and become part of plans to certify forces at certain training levels. Foreshadowing the emphasis on adaptation and innovation, the first major FORCOMD exercise in 2010 was dubbed Exercise Hamel after the First World War battle on the Western Front in 1918, during which an Australian corps demonstrated both attributes.

Training Priorities, Levels, Standards, Evaluation and Certification

Training priorities, levels, standards, evaluation and final certification would be important. These management tools would underpin the achievement of readiness in general, and specified start states at agreed points in particular. These tools were also synchronised with the Reset, Ready and Ready phases of the force generation cycle. Morrison was aligning all Army training to operational performance. The following priorities reflected his intentions:

- **Priority 1.** activities that prepare forces for operations
- **Priority 2.** activities that prepare forces for readiness
- **Priority 3.** activities that have a high public, military or international profile
- **Priority 4.** major equipment conversions
- **Priority 5.** other FORCOMD activities

These priorities were aligned to seven levels of training to be achieved over time as milestones through the three Ready, Ready and Reset phases. For example, Phase 1 Reset would focus on competency at the junior leader and small team levels (Levels 1 and 2) (see Figure 12).

Figure 12 Levels of Training in the Army Training Continuum

Level	Description
7	JFT HQ/ Bde/ Div sized formation capable of commanding and co-ordinating a Joint operation
6	Battlegroup, CS sub-unit or CSS sub-unit capable of operating in Formation context, including utilising joint assets
5	Combat Team, CS or CSS sub-unit capable of operating in a Battlegroup or Combined Arms context, including utilising joint assets
4	Sub-unit able to operate in a single Arm context
3	Platoon/ Troop able to operate in a sub-unit context
2	Section/ Team able to operate in a Troop/ Platoon context
1	Complete trade competency and a fully effective team member

Phases 2-3 { 12-18 months

Phase 1 { 8 months

Training standards would enable units and formations to train to a standard of readiness. They could lower this standard of readiness to reflect a reduction in operational commitments. Units would train to the highest standard commensurate with their assigned/expected tasks. In addition, these standards would be used to assess the readiness of force elements to be assigned to joint operations. The training standards were synchronised with the three phases of the force generation cycle (see Figure 13).

Figure 13 Training Standards in the Army Training Continuum

Standard	Description
A ¹ Ready	Trained and both practised and externally evaluated under operational conditions through MST and MRE, and achieving a satisfactory result from the external evaluation, of the collective skill or technique, and certified ready for deployment.
B Readying	Trained and practised and externally evaluated, but not under operational conditions, in the application of the collective skill or technique and ready for deployment
C ² Reset	Trained and practised in the conduct of the collective skill or technique to a standard less than that required for the operational conditions, but where the training shortfall can be provided within the time period of notice for deployment, subject to the provision of adequate resources.

¹ Standard A for collective capabilities would be achieved when assigned forces had completed MST, MRE and have been certified by COMD 1st Division. ²nd Division units would continue to conduct MRE with certification by COMD 1st Division.
² Individual training standards would be reviewed to reflect attendance on individual training courses and unit training having completed MST and MRE.

The final assurance of readiness of land forces for deployment and joint employment would be certification. As the mounting authority for land forces, COMD 1st Division would be responsible for certifying their readiness for deployment and joint employment. Thus, certification aligned responsibility and accountability. The challenge would be to give COMD 1st Division sufficient authority over enabling resources, some of which would be controlled by joint logistic and civilian garrison support agencies, to achieve the start state CJOPS had specified prior to deployment (see Chapter 5).

Lieutenant General Gillespie's CAPD was drawn from strategic guidance and would specify training levels and standards. CJOPS, Lieutenant General Mark Evans, would issue operational planning orders to focus training on contemporary contingencies and Foundation Warfighting skills. Land combat operational tasks derived from Australian Joint Essential Tasks would also link training standards to land force capabilities required for joint employment on contemporary operations. The land combat operational tasks set the context for operations and training, allowing formation commanders and commanding officers to conduct training that would relate directly to their operational role.

Assessment

Morrison specified that Army commanders would direct assessment of subordinate units to verify whether they were 'fit for purpose'. As the Army planned 'two down', he also expected 'two down' interest in evaluation and 'one down' management of formal assessment. Evaluation would review:

- exercise objectives/conditions under which the activity was undertaken
- the standard achieved
- the method of evaluation
- who was responsible for evaluation

An appropriate 'one up' commander would set, direct and assess progressive training at the lower levels. The FORCOMD major activity and exercise program would specify the culminating collective activity that commanders would use to verify readiness (training level). Ultimately, commanders would make their final assessments on training levels and standards prior to transferring force elements from specific force preparation to HQ 1st Division.

Learning Lessons

The Adaptive Army initiative envisaged lessons from operations being quickly applied to Army training so that rotating forces and contingents would be competitive and adapt rapidly during increasingly complex operations against adaptable, versatile and cunning opponents. Lieutenant General Gillespie envisaged HQ 1st Division managing a short learning loop that would be incorporated into specific force preparation (MST and MRE) that was part of the Readyng Phase of the force generation cycle. FORCOMD would manage a medium learning loop as part of generic force preparation and would also incorporate lessons into Army doctrine. Finally, AHQ would manage a long learning loop that would incorporate lessons into longer term Army capability development (see Figure 14)²⁴

Figure 14 The Learning Loops

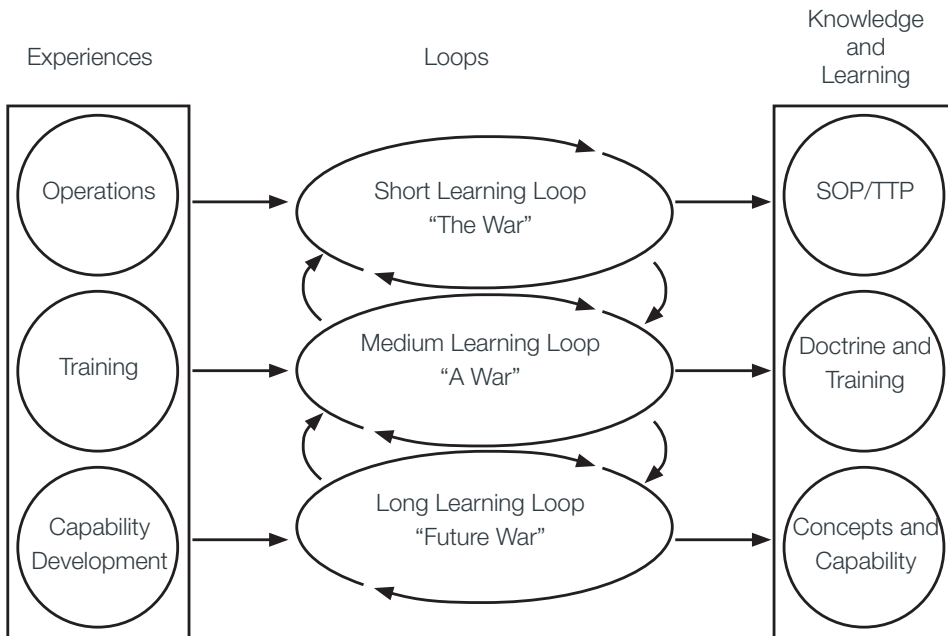

Lessons Boards would direct the dissemination of lessons from operations or training back into generic and specific force preparation. They would do so by examining operational reports from deployed force elements through HQ 1st Division, such as First 30 Day reports, mid-tour reports, post-operations reports, reconnaissance reports and special reporting, and by identifying key issues and lessons. All Army activities would be described and analysed in post-activity reports submitted to the Army Capability Management System within 30 days of the conduct of the activity. The Centre for Army Lessons (CAL) would be the mechanism for disseminating lessons throughout the Army.

²⁴ See Australian Army, Directorate of Combat Development, Army Continuous Modernisation Process Handbook, Defence Publishing Service, Canberra, 2008.

Summary

By early 2009 the Army had considered the major issues related to training and formalising arrangements for generic force preparation. Gillespie had decided on a structure for FORCOMD and its headquarters at Victoria Barracks in Sydney. He had consolidated entry-level officer and soldier training under COMDT RMC and grouped a number of specialist units into a CS&ISTAR Group.

The consolidation of individual and collective training into a continuum strengthened the relationships between training establishments and units. COMD FORCOMD would now manage resources for the Army's entire training system. For the first time the outcomes of collective training would be measured as rigorously as individual training.

The emphasis on training levels and standards drew on the strong accountabilities already contained in the Defence Training Model based on the Australian Training Quality Framework. Morrison envisaged that training levels and standards, linked to evaluation, would provide sufficient direction to enable FORCOMD to prepare forces consistently and support the development of mission command through realistic and focused training, conducted to the standard required for success on operations.

The force generation cycle drove training, preparedness, readiness and resource management. The new ATC clarified priorities and strengthened preparedness and readiness regimes. Military judgement by commanders remained important, but this professional assessment was now underpinned by empirical evidence of the competence of both individuals and force elements. The Army finally possessed sound mechanisms for gathering and applying hard-won lessons.

Preparing to Fight – Specific Force Preparation

In 2008, the CDF, Air Chief Marshal Houston, in consultation with his Strategic Command Group of service chiefs and other advisers, assigned the land forces for joint operations – the first step in the process that would ultimately prepare them to fight. Under the Adaptive Army initiative, HQ FORCOMD and HQ 1st Division would complete a gap analysis that would produce a start state (level of readiness) and agreed point (time/place) for the transfer of forces from FORCOMD to HQ 1st Division for pre-deployment training and administration.

Ideally, there would be time for HQ 1st Division to conduct pre-deployment training and rehearsal and still leave CJOPS, Lieutenant General Evans, and his headquarters at Bungendore sufficient time to rehearse land forces with the newly raised deployable joint headquarters and assigned maritime and Air Force elements prior to deployment and employment.

Concurrently, HQ 1st Division and HQ JOC planners would collaborate to produce joint concepts of operation that would optimise the employment of land forces. HQ 1st Division would exercise technical control over the preparation of land forces, and rotate and reconstitute them so as to maintain the tempo of new and ongoing overseas operations.

Over the past 30 years the process of force assignment and specific force preparation had not worked well for short-notice deployments of land forces. Now that one major general and one headquarters were responsible and accountable, there were three important lessons to apply. HQ 1st Division had to be involved in operational planning early and receive assigned forces quickly. Concurrently, COMD 1st Division required the authority and resources to raise a deployable JTF headquarters.

The other lesson from the *ad hoc* and unsatisfactory arrangements of the past concerned three surges in the supply of goods and services:

- a supply surge to 'top-up' forces with stocks and special-to-mission equipment
- a surge of administrative support for deploying personnel
- a surge of additional accommodation and base services if land forces were concentrated away from home bases for pre-deployment preparation, or just prior to embarkation on ships or loading on aircraft

In the past, raising and deploying JTF and/or national headquarters had presented a particular challenge. There had been no alignment of responsibility, accountability, authority and resources. In 2003 this challenge was compounded when the government gave command of an inter-agency intervention into Solomon Islands to the AFP. The AFP had no deployable headquarters or planning culture. COMD 1st Division, the Land Commander, COMD 17 CSS Brigade and their respective staffs had two weeks before deployment to combine and establish an inter-agency headquarters to plan the intervention. This headquarters had taken some time to mature and would not have coped had there been a complex emergency on arrival in Solomon Islands.

COMD 1st Division was responsible for ensuring that his headquarters could deploy and command a major operation, but it was not clear whether he alone would be responsible for raising a smaller joint deployable headquarters. If he had command of a high readiness brigade group each year, then he would have the authority and resources to raise and deploy both a JTF and a national headquarters. In the absence of a brigade under command, the CDF would have to nominate HQ JOC or ask CA to nominate a formation headquarters to raise smaller deployable headquarters. For example, parent brigade headquarters might raise a minor HQ JTF comprised predominantly of land forces from that brigade.

Division of Responsibilities and Command Arrangements

Five days before his public announcement of the Adaptive Army initiative on 27 August 2008, Gillespie informed the Army of the final division of responsibilities between FORCOMD and HQ 1st Division under the Adaptive Army initiative (see Figure 15).

Once Gillespie had announced the Adaptive Army initiative, Major General Richard Wilson, Commander 1st Division, became responsible for and accountable to him for conducting specific force preparation. Gillespie gave Wilson command of a new unit known as Land Combat Readiness Centre (LCRC), an amalgamation of the CTC (collective training, administration and certification) based in Townsville and 39 PSB (individual training and administration) based in Randwick, Sydney.

A contentious issue would be whether Wilson should be assigned high readiness forces annually in anticipation of the rotation of forces for ongoing operations and the most likely contingencies for that year which might force him to prepare forces at very short notice. On the face of it, this annual 'stand-by' force assignment would facilitate habitual relationships with commanders who were most likely to deploy at short notice and would be under Wilson's technical command. For example, in the past, Air Chief Marshal Houston's predecessors had given land forces an average of four weeks to plan, prepare and deploy for most operations. In 2006, however, land forces had deployed to Solomon Islands, Timor Leste and Tonga within 24–72 hours in response to crises in law and order. The prospect of similar emergencies in the future and the sudden onset of natural disasters warranted some combat forces and a deployable logistic unit maintaining high readiness for short-notice deployment. The question was whether COMD FORCOMD or COMD 1st Division should command and train these high readiness units annually.

Initially, Gillespie envisaged Wilson establishing LCRC and retaining command of the 1st, 3rd and 7th Brigades and the 1st Signals Regiment. The new COMD FORCOMD would command the 2nd Division, 16 Aviation Brigade, 17 CSS Brigade, remaining Army units and all individual training formations and establishments. After further advice and analysis, he appointed the first COMD FORCOMD, Major General David Morrison, to command the 1st, 3rd and 7th Brigades, as well as the specialist brigades and Army Reserve formations. Wilson's successor, Major General Mick Slater, would command high readiness force elements only after assignment in anticipation of deployment.

So, for the remaining five months of 2008, while Major General Morrison and Brigadier Symon reorganised AHQ into two divisions and Major Generals Kelly and Power amalgamated LHQ and HQ Training Command, Gillespie directed Major General Wilson to undertake a number of development tasks for HQ 1st Division (see Figure 16).

Figure 15 Division of Responsibilities Forces Command and HQ 1st Division – August 2008

Forces Command	HQ 1st Division
<ul style="list-style-type: none"> • Command and manage the preparedness of conventional land forces for assigned operational missions or contingencies • Receive land forces back from 1st Division and reconstitute them to agreed readiness • Conduct individual and collective training and assessment for core land warfighting skills • Command individual training institutions and training advisors • Ensure land forces are at the level of readiness directed by CA prior to assignment to 1st Division • Maintain and issue mission-specific equipment for land forces when assigned to HQ 1st Division • Retain corporate knowledge on contemporary land warfare through the incorporation of operational lessons into doctrine • Develop a system for specific force preparation, rotation and reconstitution for land forces • Provide preparedness advice to inform development for CA Capability Directive • Trial capabilities and alternative force structures based on the Army's future concepts • Introduce land capabilities into service • Provide the basis for large-scale mobilisation 	<ul style="list-style-type: none"> • Conduct joint and interagency planning in support of HQ JOC • Prepare assigned land forces for operations • Assess the readiness of assigned land forces for operations and/or directed contingencies • Provide a certified deployable JTF HQ (up to 2-star) for employment at short notice in command of a major contingency operation • Exercise technical control of deployed land forces on behalf of CA

Figure 16 Development Tasks for Specific Force Preparation - 2008

Tasks	Tasks
<ul style="list-style-type: none"> • Examine options for 1st Division exercising technical control of deployed land forces on behalf of CA • Examine options for reducing the manpower required from brigades to support Mission Rehearsal Exercises (MRE) • Review processes for allocating and accounting for resources to FORCOMD and 1st Division • Develop a three-brigade rotation model based on standardised brigades • Conduct Unit Establishment Reviews for 1st Division by the end of October 2008 	<ul style="list-style-type: none"> • Monitor restructuring to ensure that all proposals are resource neutral • Develop a plan to align HQ 1st Division with HQ JOC • Review allocation of facilities and other infrastructure to 1st Division • Develop collective training standards in conjunction with LCRC

Gillespie envisaged AHQ, FORCOMD and HQ 1st Division achieving their interim structures by 1 July 2009 and their final organisations by January 2011.

Concept for Specific Force Preparation

On 29 September 2008, Wilson presented his concept for specific force preparation to his staff. He envisaged a two-step process. Step one would involve Gillespie specifying the levels of readiness FORCOMD would maintain for the Army. Once the CDF assigned land forces for an operation, COMD FORCOMD would take the next step and assign them to Wilson for specific force preparation. Wilson divided the responsibilities of the four organisations that he now commanded (see Figure 17).

Figure 17 Organisational Responsibilities for Specific Force Preparation

Organisation	Tasks
1st Division Headquarters (Enoggera Barracks Brisbane):	<ul style="list-style-type: none"> maintain the key staff functions (including liaison with FORCOMD); maintain technical control of deployed land forces on behalf of CA; provide planning support to HQ JOC; and form the core of the DJFHQ.
Land Combat Readiness Centre (LCRC) (To be relocated from Townsville to Enoggera)	<ul style="list-style-type: none"> mount and demount land forces including MST, individual preparation and maintenance and issue of items from Pre-Deployment Training Fleet (PDTF) equipment. secondary effort would be the assessment of land forces in the conduct of combined arms training, joint exercises and other activities (including International Engagement (IE) activities); timely application of the lessons learned process, including dissemination to FORCOMD and, where relevant, the wider ADF.
1st Signals Regiment	<ul style="list-style-type: none"> provide command and control systems support to HQ 1st Division; and be prepared to provide command and control, and sustainment support to DJFHQ in accordance with readiness notice.
Brigades	<ul style="list-style-type: none"> provide force elements for operations and contingencies as directed; support the LCRC mounting and demounting process; and be prepared to provide the foundation for a minor JTF HQ

But he remained concerned about when and how force assignment would occur. Ideally, FORCOMD would 'top-up' assigned forces with personnel and materiel before they began specific force preparation. COMD FORCOMD commanded 17 CSS Brigade, the formation equipped to do this job. Typically, force assignment gave deploying force elements the authority to draw on the joint logistic system for stocks and equipment, but previous short-notice deployments had shown that there might not be sufficient time to top-up forces prior to assignment to HQ 1st Division for pre-deployment training.

Wilson also noted that, while he had responsibility and accountability for maintaining mission-specific equipment and what he described as the Pre-Deployment Training Fleet (PDTF), he did not have authority over a logistic unit that would:

- hold, issue, restock
- receive and issue special-to-mission equipment
- maintain the PDTF
- rapidly acquire new equipment

In the current situation he had to 'make do' with LCRC and 39 PSB and his headquarters staff to manage specific force preparation. But he had no assigned logistic unit with the capacity to manage the top-up of units and larger contingents with classes of supply and mission-specific equipment.¹

Wilson also envisaged a 'demounting' process for forces returning from operations or rotating from high readiness back to lower readiness levels. Parent brigade headquarters and the assigned logistic unit would be crucial to this process.

Wilson believed that an important prerequisite for the success of the new Adaptive Army initiative would be the annual assignment of a brigade group to HQ 1st Division with the following concurrent tasks:

- maintain specified force elements at high readiness for short-notice deployment
- maintain technical control of its deployed forces

¹ Class 1: rations; Class 2: clothing and individual equipment; Class 3: petroleum, oil and lubricants; Class 4: construction materials, fortification and barrier materials; Class 5: ammunition; Class 6: personal items, such as health and hygiene products, soaps and toothpaste, snack food, beverages; Class 7: major items such as tanks, vehicles, generators, weapons; Class 8: medical; Class 9: repair parts and maintenance items; Class 10: material to support non-military programs not included in Classes 1–9.

- conduct specific force preparation for new operations and rotations in conjunction with LCRC
- be prepared to provide the foundation for a minor HQ JTF

Rotation of Land Forces – Force Generation Cycle

Rotation of land forces between FORCOMD, 1st Division and HQ JOC using the Reset, Readying and Ready model represented a major challenge. There were many difficult questions concerning responsibilities, accountabilities, authority and resources. Several related to implementing a generic three-phase, eight-month rotation cycle – the force generation cycle. This model was based on an Army structure of ‘threes’. Major General Morrison had specified that the three regular brigades follow a three-phase cycle of:

- Ready: eight months on high readiness for contingency tasks and meeting overseas operational commitments
- Readying: eight months’ training and preparing for high readiness and overseas operations
- Reset: eight months reconstituting after eight months of high readiness and overseas deployment

Wilson set the force general cycle for the next two years (see Figure 18).

Figure 18 Force Generation 2008-2010

2008		2009												2010											
O	N	D	J	F	M	A	M	J	J	A	S	O	N	D	J	F	M	A	M	J	J	A	S	O	N
1 Bde Deployment								DM	1 Bde Remediation					1 Bde Core Trg					MSTMRELve	1Bde Deploy					
3 Bde Core Trg				MSTMRELve				3 Bde Deployment					DM	3 Bde Remediation					3 Bde Core Trg						
7 Bde Remediation							7 Bde Core Trg					MSTMRELve		7 Bde Deployment					DM	RM					

DM - De Mount RM - Remediation

The force generation cycle was a useful management construct, but would rarely fit neatly with operational realities. It assumed that, during the high readiness/overseas deployment phase, most members of one of the three regular brigades would either be on standby, involved in specific force preparation, deployed or supporting deployed personnel and their families from barracks. This situation would apply when the operational tempo was high and most of the brigade’s capabilities were required for contingencies.

The pattern since the precautionary deployment of an embarked company group evacuation force in 1987 had comprised operations involving corps-based groupings. Typically, a high readiness brigade could provide one or possibly two groups, such as an infantry company group, an engineer squadron, medical support team, logistic support team and a communications team, for the initial deployment. Rotations, normally after six months of operations, had come from other brigades.

The other challenge for the force generation cycle was that the Army did not have ‘threes’ in some key enabling capabilities. For example, 17 CSS Brigade had two dissimilar Regular force support battalions and ‘ones’ of particular capabilities that could be in high demand, such as petroleum operators and terminal operations staff.

Training for ‘A War’ and ‘The War’

The force generation cycle incorporated the doctrinal concepts of preparing for ‘a war’ and preparing for ‘the war’. FORCOMD would be responsible for the Army’s preparation for ‘a war’ – defined as ‘a generic conflict within a general threat environment, in which land assets are able to conduct sustained operations against a recognisable enemy for a specific purpose.’²

Thus, FORCOMD would concentrate on Foundation Warfighting training, the fundamental individual and essential collective training that underpins capability and readiness for the lines of operations described in Adaptive Campaigning. High readiness forces within FORCOMD would be those identified for specific contingencies. These forces would be trained to the highest appropriate readiness levels, short of conducting MST and MRE.

HQ 1st Division would train assigned forces for ‘the war’ – defined as ‘the specific conflict within a specified threat environment in which land forces are currently deployed or about to deploy with a known or specific mission.’³ Training for ‘the war’ involves MST and MRE that build on Foundation Warfighting training, enabling forces to accomplish specified missions.

Rehearsing forces for ‘a war’ and ‘the war’ would divide responsibilities for planning and conducting major annual field exercises. COMD FORCOMD and his staff would be responsible for planning and conducting exercises that rehearsed Foundation Warfighting. COMD 1st Division and his staff would be responsible for planning and conducting exercises that rehearsed stabilisation operations and other specialised activities related to contingencies such as emergency evacuations.

Both HQ FORCOMD and HQ 1st Division would need sufficient exercise planning and management staff and the authority and resources to coordinate maritime and air support for exercises. In addition, either COMD FORCOMD or COMD 1st Division had to be responsible for non-operational deployments, such as sub-unit and individual exchanges with major allies, as well as preparing sub-units and individuals for domestic operations such as border protection, Army engineer assistance to indigenous Australian communities and disaster relief.

For COMD FORCOMD and COMD 1st Division to measure and certify the performance of forces training for ‘a war’ and ‘the war’, as well as individuals and contingents preparing for deployment to ‘the war’, both required the services of the new LCRC. It would be up to Gillespie and his staff to set priorities through a new CAPD.

The Agreed Point

Wilson had been right to identify the importance of what he called ‘the CHOP line’ between HQ FORCOMD and HQ 1st Division for assigned forces. Developing doctrine described Wilson’s ‘CHOP line’ as ‘the agreed point’. This was a term routinely used to describe a location where a logistic organisation would deliver stocks and another logistic organisation would then take responsibility for their storage and onward distribution.

Thus, the agreed point was a delivery point for personnel and materiel, and an agreed time for transfer of responsibility, authority, resources and accountability. These were useful notions for a time and/or place at which HQ FORCOMD would deliver generically prepared land forces to HQ 1st Division for specific force preparation. The notion of agreement would necessarily include the level of readiness of those forces, both in terms of proficiency and sustainability for operations (later to be defined as the start state). Proficiency related to the competence of headquarters, force elements and individuals. Sustainability related to the quality and serviceability of weapon systems, vehicles, equipment and stocks that assigned land forces needed to bring with them to begin specific force preparation.

2 Major General D.L. Morrison, ‘The Army Training Continuum’, LHQ/OUT/2009/X1194355, Land Headquarters, c. June 2009.

3 Ibid.

The Start State

Under Adaptive Army arrangements, Lieutenant General Gillespie and his successors would specify training levels and standards for the Army in an annual CAPD and other directives.⁴ The CAPD would specify start states for FORCOMD to achieve prior to assigning forces to HQ 1st Division for specific force preparation. Thus, land forces would be handed over and handed back at an agreed point having reached agreed start states. A start state comprised:

- training level and standard (proficiency in Foundation Warfighting)
- force structure (current organisation of elements compared to authorised/recommended organisation)
- manning (number of positions within the organisation occupied by qualified and experienced personnel)
- equipment (holding of equipment compared to authorised holding)
- readiness (time required to prepare for deployment)
- sustainability [stocks on hand compared to stocks needed for Operational Viability Period (OVP)]

The Surges

The concepts of agreed points and start states were useful management tools but were dependent on surges of logistic and garrison support. COMD 1st Division would also have to negotiate a surge of support from CJLOG and Head National Defence Support Operations. Protocols and standard operating procedures would be required to specify arrangements for creating the required surges. Both FORCOMD and HQ 1st Division would depend on local JLU, local DSG offices and joint movements cells to plan and deliver these surges.

Typically, a reallocation of resources from FORCOMD to HQ 1st Division would also be required. At short notice, COMD FORCOMD might have to forego scheduled Foundation Warfighting training to direct effort and resources to COMD 1st Division to enable him to meet start states specified by CJOPS and HQ JOC. In particular, COMD 1st Division would have to ask COMD FORCOMD for specialist planning staff, as well as aviation and logistic support from 16 Aviation Brigade and 17 CSS Brigade respectively, to support specific force preparation.

Conclusions

The main challenges in preparing to fight would involve synchronising and managing the command status and the resources of the Army's formations and units within the force generation cycle (Ready, Readying and Reset). Once personnel administration and resource management were factored in, assigning land forces to and from FORCOMD and HQ 1st Division on an annual rotational basis became impractical.

The force generation cycle depended on an Army of 'threes' and the unlikely prospect that a high readiness brigade could provide all the force elements required for initial employment and first rotation. There were only 'ones' or 'twos' of many logistic, communications and specialist support units and sub-units in the Army. The imperative would be to create three similar brigades and either raise more logistic support and specialist units, or accept the risks associated with reduced Reset time for existing units and sub-units.

The concept of training for a generic conflict ('a war') and current operations ('the war') was sound, but may not have gone far enough. Governments sometimes directed land force projections at

⁴ Common tasking statements in the CAPD would assign tasks, training levels and standards for land forces.

little notice for unexpected contingencies to unfamiliar areas of operation with political and strategic sensitivities.⁵ Continuing the allegories, land forces that were ready for 'a war' and 'the war' would also need to be prepared for 'the next war'. Four of the major challenges for responding to largely unforeseen and unrehearsed emergency situations – 'the next war' – comprised:

- raising, preparing and deploying a customised minor JTF HQ
- designing, developing and delivering special-to-mission training, normally with additional cultural awareness content
- efficiently topping-up deploying forces with personnel and supplies prior to deployment
- packing and loading
- quickly establishing an efficient and effective supply chain

Major General Wilson identified some of these challenges in September 2008. At that time HQ 1st Division did not have an assigned logistic unit to top-up deploying forces with the classes of supply and mission-specific equipment and stocks, or an assigned movements/terminal organisation to assist them to pack and load.

In 2008, the processes of raising, preparing, rehearsing and deploying customised or minor JTF HQ for particular contingencies, especially those involving other government departments and agencies, was not well defined or rehearsed. The options were for COMD 1st Division to establish a minor JTF HQ by assigning members of his own staff or through rapid force assignment of a brigade headquarters from FORCOMD to HQ 1st Division in order to raise an improvised JTF HQ.

Some useful concepts emerged in the final months of 2008 concerning how to assign forces to and from FORCOMD and HQ 1st Division and to and from HQ 1st Division and HQ JOC. The agreed point and the start state focused planners on essentials that would apply past lessons. Each concept was founded on the importance of handing over authority, responsibility, accountability and resources efficiently at particular places and/or times in the most optimal circumstances in order to facilitate initial deployment, employment and subsequent rotations.

Of equal importance was the need for shared understanding of the proficiency of personnel, stock holdings and logistic support arrangements. The OVP that specified the period of self-sustainability before a supply chain commenced operations was fundamental to achieving the start state.

While not specified by Wilson and his staff in September 2008, the viability of the agreed point and achieving the start state depended on surges of logistic, movements, training, administrative and garrison support. There would have to be a number of cooperative relationships between local JLU and DSG offices and protocols for specific force preparation for these surges to work well.

Except for small contingents and headquarters staff that might concentrate elsewhere for specific force preparation, LCRC would have to coordinate pre-deployment training (MST and MRE) in main brigade bases in Darwin, Brisbane or Townsville using local training infrastructure and exercise areas. The LCRC would not have sufficient staff or authority over training infrastructure and resources to conduct specific force preparation by itself. Staff at LCRC would have to design MST, MRE and individual training programs with subject matter experts provided by FORCOMD and employ FORCOMD units to support pre-deployment training and administration.

Thus, there would be competing priorities within FORCOMD between delivering Foundation Warfighting training and supporting unforecast specific force preparation. HQ 1st Division would not control the enabling infrastructure or resources to meet its responsibilities and accountabilities for specific force preparation. Wilson and his staff would have to negotiate authority and resources with COMD FORCOMD and his staff who may have booked and planned other training activities for the same period.

5 For example, projections to Somalia (1993), Rwanda (1994), Bougainville (1994), Bougainville (1997), East Timor (1999), Solomon Islands (2003), waters off north-west Australia (2003), Aceh (2004), East Timor (2006), Solomon Islands (2006), Timor Leste (2006) and the Northern Territory (2007).

FORCOMD and HQ 1st Division would have to achieve a supported/supporting relationship. Indeed, COMD FORCOMD would preside over centralised planning and management of resources for both FORCOMD and HQ 1st Division. Thus, two major generals would have to agree on the priorities of effort and allocation of resources to generic and specific force preparation each year, as well as reschedule activities and reallocate resources at short notice when a joint, combined or inter-agency force had to be prepared quickly in response to an overseas emergency.

Those in the 4D group who were instrumental in developing these new arrangements in the first half of 2008 wanted to avoid the old dynamic of the major general in Sydney, who was responsible for generic force preparation, appearing to be senior to the major general in Brisbane responsible for the preparation of assigned land forces and raising HQ JTF. The philosophical founding fathers wanted 'contested advice', not necessarily agreement among peers or higher level 'group think'. They wanted CA to make the judgement call, with finite resources, between the investment in generic and specific force preparation. They wanted this judgement to be an enduring and constant feature of the way the Army operated.⁶

What Brigadier Symon and the 4D group may have missed was that the contest for resources, and control and coordination of specific force preparation would be between two lieutenant generals, four major generals and a public servant, not just between Morrison and Slater. Gillespie commanded Morrison and Slater and could allocate priorities for them. However, in 2009, Gillespie would need to negotiate with Lieutenant General David Hurley, VCDF, for surges of logistic support from Major General Grant Cavenagh, CJLOG, as well as Simon Lewis, Deputy Secretary Defence Support, for surges of garrison support from Major General Elizabeth Cosson, Head Defence Support Operations.

The next chapter explores surges of goods and services for specific force preparation and establishing supply chains. Successful generation of land forces for joint employment depended on the efficiency and synchronisation of these enabling activities. Morrison needed logistic and garrison support to bring land forces to agreed start states at agreed points for transfer to Slater. Slater needed surges of the same support to prepare assigned forces to achieve the start states specified by Lieutenant General Evans, CJOPS, and HQ JOC. Evans needed logistic and garrison support for deployment and concurrent logistic support to establish and prime a supply chain to sustain his employment of land forces. The question was whether logistic and garrison support for the preparation, deployment and sustainment of land forces was properly married and would stand the test of a short-notice projection of land forces.

6 E-mail, Major General P.B. Symon, 23 April 2010.

Preparing to Deploy and Establishing Supply

In 2009 the preparation and projection of land forces depended on logistic, administrative and base services surges and several transactions. Surges were required for both pre-deployment force preparation and force rotation, and transactions involved the handover/takeover of land forces between FORCOMD and HQ 1st Division, and between HQ 1st Division and HQ JOC, and *vice versa*.

The first and most important surge was the process of topping-up deploying forces with personnel and materiel in FORCOMD for transfer to HQ 1st Division in order to prepare them for a new operation or a rotation for an ongoing operation. Typically, this surge would continue in order to close any gaps between the start state of deploying forces being prepared by HQ 1st Division and the start state required by HQ JOC prior to deployment. This continuation included the issue of special-to-mission equipment, clothing, weapons and technology. The second surge comprised the provision of additional administrative and medical staff and services to prepare personnel for overseas service. The third surge involved increasing garrison services to support concentrations of Australian and possibly coalition forces at base locations for specific force preparation, as well as deployment from airfields and ports.

These surges and handover/takeover, traditionally known as mounting and mounting base operations¹ or, in more modern parlance 'force generation', are preliminary operations in their own right. Designated headquarters have to plan, direct and coordinate these using assigned resources. Nominated commanders and their headquarters must have clear responsibilities and accountabilities, authority and resources.

Under the new Adaptive Army arrangements, HQ 1st Division would be the mounting authority for land forces. It would be responsible for articulating the agreed point and start states in consultation with HQ JOC and summoning the three surges. Major General Morrison, COMD FORCOMD, would support Major General Slater, COMD 1st Division, by nominating a mounting headquarters.² The mounting headquarters would be responsible for coordinating the surges and working with LCRC to deliver pre-deployment training.

1 Mounting operations involve concentration and pre-deployment administration and MST and MRE. Mounting base operations represent the surge of movements planning, logistic support, garrison services and loading necessary to support the preparation of land forces for deployment and the establishment of supply.

2 Difficulties will occur if the headquarters of the brigade providing most of the land force elements is also providing the bulk of staff for a deploying JTF HQ. An ad hoc mounting headquarters would need to be established.

The Army depended on joint and civilian logistic and administrative organisations to provide surges and to support handover/takeover. By 2009, as the Adaptive Army structure was being implemented, joint command and control arrangements for logistic support to pre-deployment preparations and subsequent sustainment of operations were well established. They had been instituted in the aftermath of the major ADF deployment to East Timor in 1999. The question was how well these arrangements supported the new Adaptive Army structures.

Command and Control of Sustainment

In 2009 Major General Grant Cavenagh was CJLOG. He was responsible for the performance of Defence logistics in support of operations and accountable to the CDF, Air Chief Marshal Houston, at three levels of command simultaneously. His responsibilities were exercised through his strategic-level headquarters in Canberra and an operational supply chain headquarters in Melbourne. At the strategic level in Canberra, he was the Joint Logistics Capability Manager, accountable for the overall system performance of Defence logistics. Brigadier David Saul, Director General Strategic Logistics, and his branch in Canberra determined and harnessed the organic Defence, domestic and international support required to generate and maintain capabilities in readiness for Defence operations.

At the operational level, Cavenagh commanded JLC from a headquarters in Melbourne (HQ JLC) that comprised a number of JLU (warehousing, distribution and maintenance services) dispersed around Australia which were also known as business units. HQ JLC and its business units worked closely with all areas across Defence and with commercial goods and services contractors to deliver logistics support required by the service chiefs of Navy, Army and Air Force for generic force preparation and by CJOPS to support and sustain forces deployed on operations. The Director General Supply Chain Branch, Commodore Clint Thomas, RAN, at HQ JLC in Melbourne, was responsible to Cavenagh for the planning, coordination, delivery and analysis of domestic and overseas logistic support to ADF operations, exercises and CDF-directed activities. For land operations, Thomas worked closely with the Director General Land Close Combat Systems, DMO, Brigadier Bill Horrocks, who was responsible for the acquisition, fleet management, through life support and disposal of land close combat systems.

Brigadier Andy Sims, Director General Support, HQ JOC, planned and coordinated the sustainment of ADF operations in conjunction with representatives from the services, DMO and HQ JLC. Thomas and his staff in Melbourne contributed to logistics planning conducted by Sims at Bungendore, as well as coordinating, arranging and managing logistic support to ADF operations, exercises and contingencies.

Two peers, Brigadier Andrew Sims at HQ JOC, and Commodore Clint Thomas, at HQ JLC were jointly responsible for:

- a. concentration and distribution of stocks for assigned forces
- b. planning and delivery of supply chain capabilities
- c. the establishment and priming of supply chains to sustain land forces following deployment (initial priming would be with sufficient stocks for an OVP of 30–60 days)

Major General Elizabeth Cosson, Head Defence Support Operations, DSG, was responsible for delivering garrison services to support the concentration and sustainment of assigned land forces in mounting bases. The challenge was to increase the quantity of goods and services provided by contractors at short notice. For short-notice high-tempo preparations, goods and services would have to be delivered around the clock. In 2009, DSG did not have the capacity or remit to operate seven days a week or 24 hours a day. Military personnel would have to establish an ad hoc headquarters to coordinate 24-hour delivery of goods and services in mounting bases.

Major General Cavenagh did not command deployable maritime, land or air logistic support units. At the onset of a force projection, the CDF had to assign them to him from each service. The

service chiefs would then prepare assigned logistic elements for Cavenagh to employ through Brigadier Andrew Sims at HQ JOC. Significantly, Lieutenant General Evans, CJOPS, commanded Sims, not Cavenagh.

Brigadier Sims was responsible for operational-level logistic planning and operations. In conjunction with one-star peers at JLC (Thomas) and DMO (Horrocks) in Melbourne, he was responsible for supporting handover/takeover from HQ 1st Division to HQ JOC at an agreed point, and for establishing and priming supply chains to deployed land forces. He was accountable to both Lieutenant General Evans and Major General Cavenagh for the sustainment of operations.

Sims' job involved convening logistic planning meetings with representatives from the three services, JLC, DMO and 1 Joint Movements Group (1 JMOVGP) and developing Logistic Support Orders for operations. Brigadier David Saul's remit, on behalf of Major General Cavenagh, was to conduct strategic logistic planning and activate international agreements for the sustainment of offshore ADF operations.

Thus, Cavenagh depended on collegial management arrangements one level below him to meet his responsibilities and accountabilities to the CDF, via the VCDF, Lieutenant General David Hurley, not a chain of command that extended from him to deployed logistic elements from the three services that operated supply chains to deployed forces. Sustainment of ADF operations was a function of Lieutenant General Mark Evans' command, not Cavenagh's.

The Process

In 2009 the process for providing logistic support for the preparation of assigned land forces for operations, and establishing and priming supply chains to these forces following deployment was:

- **Step 1.** Strategic Command Group would provide strategic guidance for a forthcoming operation and issue planning directives, and the CDF would assign forces
- **Step 2.** VCDF would direct CJLOG to support the operation, i.e. establish and command a mounting base for deploying land forces; establish and manage a supply chain to an agreed point; establish, manage and exercise technical command of logistic information systems; provide materiel support to deployed forces; and advise 1 JMOVGP on the movement of sustainment stocks
- **Step 3.** CA would warn assigned land combat and logistic support elements for joint employment
- **Step 4.** COMD FORCOMD would transfer assigned land forces to COMD 1st Division at agreed points and at specified start states
- **Step 5.** COMD 1st Division would conduct pre-deployment training and hand over assigned forces to CJOPS at agreed points and at specified start states for deployment

In order to generate logistic support within Australia, Cavenagh commanded a network of regionally located JLU that provided warehousing, distribution and maintenance services to Navy, Army and Air Force customers. To secure garrison support for pre-deployment preparations, he had to negotiate with Major General Cosson to increase the provision of services at mounting bases.

Cavenagh depended on force assignment for deployable logistic assets to manage supply chains and provide force-level support in theatre. Assets for land force sustainment, including in-theatre helicopter support (17 CSS Brigade and 16 Aviation Brigade), belonged to Major General David Morrison, COMD FORCOMD. The deployable force-level logistic headquarters was located with 17 CSS Brigade in Randwick, Sydney. Aside from making ad hoc arrangements, there was no rehearsed and deployable force-level logistic support staff group elsewhere in the Army. Thus, the planning and management of supply chains to land forces depended on Sims at HQ JOC convening planning conferences as early as possible with logisticians from HQ 1st Division, his point of contact with the Army.

Role of 17 CSS Brigade

In January 2009 Brigadier David Creagh took over command of 17 CSS Brigade, the formation responsible for terminal operations and force-level sustainment of land forces in Australia and overseas. This formation was spread from Darwin to Tasmania, with a headquarters in Sydney. Most units were located in and around Brisbane and Townsville. The brigade's major units were two Regular and one Reserve force support battalions (FSB) (terminal operations and supplies distribution, mostly by road, air despatch and small landing craft) supported by a signals regiment (communications), three health support battalions (field hospitals) and a psychology unit. This brigade also provided the deployable HQ Force Logistic Support Group (HQ FLSG) for larger scale force projections.

Formerly known as the Logistic Support Force, the brigade had performed magnificently in a large-scale short-notice projection of force into East Timor in 1999. Over a period of two weeks, the brigade had planned and begun to deploy two FSB (9 FSB to Darwin, and 10 FSB to Dili), and raised and deployed an ad hoc HQ FLSG and a field hospital.³

While Major Generals David Morrison and Mick Slater depended on Brigadier Sims at HQ JOC to coordinate joint and service logisticians, and public servants for mounting base operations that topped-up deploying land forces and established supply chains, they depended on Creagh for terminal operations at ports and airfields. Creagh both 'pitched' and 'received' supplies. In Australia his operators ran port and airfield terminals that received, stored, loaded and despatched stocks. Overseas, his operators ran ports and airfield terminals that received, stored and distributed stocks to land forces at agreed points. Thus, while Brigadier Sims and his staff at HQ JOC planned and issued orders for the sustainment of land forces, Creagh delivered sustainment in the field.

Preparing and deploying elements of 17 CSS Brigade was crucial for sustaining land forces offshore. Consequently, this formation not only needed to be ready and prepared under Morrison's direction in FORCOMD, but also included as soon as possible in operational-level planning so its elements could support land force deployment and RSO&I, as well as establishing and providing warehousing and distribution operations at ports and air fields in support of joint employment of land forces.

Under the new arrangements for specific force preparation, at some point, Morrison would have to assign elements of the brigade to Slater for specific force preparation, an untried concept for logistic support units that were often too busy topping-up and administering deploying forces and establishing supply chains to the area of operations to have time for their own specific force preparation.

Response to Adaptive Army Initiative

When the Adaptive Army initiative was launched in 2008 Brigadier David Saul commanded 17 CSS Brigade. He had conducted a mission analysis with his staff on what the Adaptive Army initiative would mean for the brigade and submitted it to LHQ in late September. In his analysis he pointed out that arrangements for specific force preparation and rotation of logistic units still required clarification. He noted that logistic planning for operations would now occur at HQ 1st Division in Brisbane, rather than at LHQ in Sydney.

In 2009 the Adaptive Army initiative did not change the role of 17 CSS Brigade or its command and control arrangements. The brigade would remain under the command of Major General Morrison and support FORCOMD exercises and other training activities. It would continue to be responsible for supply chain management and distribution capabilities (water, beach operations, air despatch), as well as force-level support, including preparation and provision of health and psychological services, during joint, combined and inter-agency operations. The brigade would also provide a logistic component commander and staff to JTF commanders and assist with supply chain accountability.

³ See Breen, *Mission Accomplished*
66

Marrying Up Sustainment Planning

It was crucial for 17 CSS Brigade to be involved in planning as early as possible to maximise preparation time for its logistic units. It was also crucial for Sims and his staff at HQ JOC to authorise JLU to order and concentrate stocks for specific force preparation and deployment. Contractors and support units would need as much time as possible to create the three surges of goods and services required to prepare and deploy land forces with sufficient stocks for the OVP and to prime supply chains with sufficient stocks thereafter. Creagh and his staff also needed time to coordinate with JLU the receipt, preparation and loading of stocks for deployment from ports and airfields.

In 2009, 17 CSS Brigade was not in the best position to participate in joint sustainment planning quickly or directly. Creagh and his staff were responsible for providing technical advice for planning supply chains to HQ FORCOMD and HQ 1st Division, not HQ JOC. Sims and his staff were authorised to plan in conjunction with logistic planners at HQ 1st Division, but not directly with Creagh and his staff.

Slater and his staff at HQ 1st Division, who were responsible for the Army's input into operational-level planning at HQ JOC, would have to seek approval from Morrison to draw on Creagh and his staff for advice and assistance. Alternatively, Creagh could seek approval from Morrison to assign members of his planning staff to HQ 1st Division, and then ask COMD 1st Division, Major General Slater, for assigned staff to participate in joint planning at HQ JOC. Either way, these were clumsy 'top-down' or 'bottom-up' processes that could fall foul of the practical difficulty that logistic planning at HQ JOC could be compartmentalised.

Creagh also did not have a direct link to Cavenagh's supply chain manager, Commodore Clint Thomas in Melbourne, who was responsible for supplying joint forces that would largely comprise land forces. Terminal operations would be crucial for the management of supply chains. Once again ad hoc arrangements would have to be made at the onset of a force projection so that Creagh and his staff could plan with Thomas and his staff, and possibly consult with Brigadier Horrocks and his staff at DMO.

Summary

The preparation and projection of land forces depended on logistic and administrative surges, efficient handover/takeover and supply chains. In 2009, Major General Morrison, COMD FORCOMD, and Major General Slater, COMD 1st Division, depended on Major General Cavenagh, CJLOG, for pre-deployment logistic support to deploying land forces.

The CDF had to assign service logistic units to Lieutenant General Evans to operate supply chains. Evans would depend on Cavenagh to establish and manage sustainment of deployed forces, in conjunction with Evans' Director General Support, Brigadier Sims. In effect, Evans commanded logistic units on operations, but Cavenagh's staff in Melbourne managed them in conjunction with Sims' logistic staff in Bungendore.

The Army's 17 CSS Brigade was the ADF's logistic 'muscle group' for supporting land forces offshore. Under the Adaptive Army initiative, Major General Morrison commanded both this brigade and 16 Avn Brigade which provided medium lift helicopter support. The crucial factor for establishing and managing supply chains would be the involvement of 17 CSS Brigade in joint operational-level planning as early as possible at the onset of a projection. In 2009, the processes for doing so required clarification.

The question over sustainment concerned whether Cavenagh's responsibilities and accountabilities for mounting base operations and establishing supply chains were matched with sufficient authority and resources. In particular, did he and his staff in Canberra and Melbourne have both the authority and the habitual relationships with those controlling the resources

for supporting pre-deployment preparations, staging (if required) and the establishment and management of supply chains to the agreed point?

Helpfully, CJOPS, Lieutenant General Evans, and Cavenagh both reported to the VCDF and both had capable operational-level headquarters, though geographically separated from each other in Canberra and Melbourne. The relationship between Brigadier Sims at HQ JOC and Commodore Thomas at HQ JLC was crucial. Their accountability to Evans and Cavenagh respectively for the sustainment of land forces operating offshore necessitated frequent contact and collaboration.

Base support services would also be crucial for force preparation. When a surge of garrison support for mounting base operations was required, the VCDF, Lieutenant General Hurley, and Deputy Secretary Defence Support, Simon Lewis, would have to authorise Cavenagh and Major General Cosson, Head Defence Support Operations, to negotiate arrangements. Lewis was responsible for DSG which was structured into five divisions: Defence Health Services, Defence Legal, National Operations, Personnel Services, Infrastructure and a Corporate Management Branch. The DSG provided essential services and support, mostly through commercial contractors, to over 90,000 personnel at every Defence site in Australia. In practice, Cosson's Director General Base and Support Services, Air Commodore Michael Maher, would have to join Sims and Thomas to plan mounting base operations. These arrangements were not clear and unpractised in 2009.

One of the challenges for these command and control arrangements for preparing to deploy and establishing supply chains was to efficiently connect Brigadier Creagh at 17 CSS Brigade and his logistic planning staff to Sims and his planning staff. Sustainment planning had to be married up quickly because logistics preparations needed sufficient warning time, authority and resources to allow stocks to be prepared, moved, packed and loaded.

While 17 CSS Brigade, including its deployable logistic component commander and headquarters staff, remained in FORCOMD, Creagh's planners would not have direct and habitual links to operational and logistics planners at HQ 1st Division or HQ JOC. Technically, Creagh and his staff could not talk to Sims and his staff directly until Lieutenant General Gillespie assigned elements from his brigade to HQ JOC and/or Morrison in Sydney and Slater in Brisbane gave permission for direct contact between Sims and Creagh before force assignment when initial planning began. The challenge would be to overcome the secrecy in Canberra that had cut preparation time for topping-up units and establishing supply chains in the past.

In 2009 the other major challenge for these arrangements was the reliance on collegial peer relationships for logistics planning and the process of establishing supply chains. Sims and his staff had the difficult task of issuing timely guidance for supporting specific force preparation as well as comprehensive supply chain instructions. He had to be the first among equals and negotiate with peers in JLC, DMO, DSG and 17 CSS Brigade, as well as logisticians at service headquarters, including HQ 1st Division and 1 JMOVGP.

Implementing Change

In 2009 the substantial task of changing the Army's operational-level command and control arrangements for the preparation of land forces for joint employment fell to Major General David Morrison, the inaugural COMD FORCOMD, and Major General Mick Slater, newly appointed COMD 1st Division. At the same time, Major General Paul Symon, the newly appointed DCA, was dividing Army Headquarters to form Modernisation and Strategic Planning Division and establish the appointment of Head Capability Development-Army (HCD-A). Brigadier Shane Caughey, the inaugural Chief of Staff FORCOMD, and Brigadier Simone Wilkie, the inaugural Director General – Training, HQ FORCOMD, became responsible for the practical business of amalgamating LHQ and HQ Training Command at Victoria Barracks in Sydney.

At Enoggera Barracks in Brisbane, Slater appointed his Chief of Staff, Colonel Mark Brewer, to design the internal staff arrangements for managing the specific force preparation and rotation of assigned forces. Brewer was also responsible for the interface arrangements between HQ 1st Division and HQ JOC, including technical command of deployed land forces through HQ JOC. Slater appointed Brigadier Peter Clay, his Deputy Commander, to command LCRC and Colonel Ross Perot, an experienced project officer, to establish the processes for specific force preparation and to describe those processes in a force preparation handbook.

In addition, Brigadier Jeff Sengelman had the daunting task of establishing a brigade-sized formation (3000 personnel) comprising Land Command's former direct command units and other specialist units. This formation began with the rather awkward title of CS&ISTAR Group, but would become the 6th Brigade in due course.

Amalgamating LHQ and HQ Training Command

Major General Morrison realised from the moment he assumed command that two organisational tectonic plates would inevitably rub together during and after the amalgamation of the two headquarters at Victoria Barracks.¹ Land Command had originated from the post-Second World War army organisation that had its roots in the formations and units of the pre-war period. These formations had antecedents in the First World War Australian Imperial Force and militia formations and units. In 1973, following the Hassett Review, the Chief of the General Staff designated formations and units of the Army as the Field Force and the headquarters in Victoria Barracks became HQ Field Force Command. This headquarters commanded the three divisions of the Army and a group of miscellaneous units that originated in the old corps troops construct. In 1987

1 Interview with Major General D.L. Morrison, 3 December 2009.

Field Force Command was renamed HQ Land Command and the formations and units of the Army became Land Command formations and units. Land Command's ethos was traditional and governed by traditional hierarchical processes and the wills of commanders.

Training Command was established in the early 1970s for the management of the Army's training schools, governed by a systems training model that had been adopted from the US Army and the US Marine Corps. It had been organised and operated like a corporate business unit for almost 40 years. Training schools for each corps of the Army were static and fully integrated with Defence garrison support functions and processes. HQ Training Command managed a training system that had well-established operating procedures and performance measures.

The challenge for Morrison was to blend the best of the ethos and operating imperatives of each command. There had to be respect for both a systems approach to training and for the judgement of commanders who would be responsible for leading troops to fight and win. The blending began at the top and was informed by guiding documents produced in 2008.

Morrison directed the development of several key guiding documents. His ATC directive synchronised all individual and collective training.² For the first time the Army's individual training in schools and collective training activities in units would be regulated by formal training levels and standards that Morrison and his staff would manage on behalf of the CA.

In November 2009 Morrison issued a comprehensive operations instruction and began convening quarterly synchronisation meetings to guide and gauge the progress of the ATC.³ Importantly, brigade commanders and representatives from AHQ, Special Operations Command and HQ 1st Division also attended. Resource management issues were discussed and problems solved in ways that would have been impossible when Land and Training Commands were separate. A combination of these synchronisation meetings and the turnover of staff through the posting cycle would inevitably result in the development of a new training management ethos.

Reorganisation at Victoria Barracks

Brigadiers Caughey and Wilkie arrived at Victoria Barracks, Sydney, in January 2009 on promotion having graduated as fellow students from CDSS in late 2008. Neither had been involved in the development of the Adaptive Army initiative or the final organisational model.

Fortunately, Major General Ash Power had included Caughey and Wilkie as observers when he had briefed Lieutenant General Gillespie on the recommended HQ FORCOMD organisation in November 2008. They understood the challenges implicit in amalgamating two very different headquarters by 1 July 2009 when HQ FORCOMD would commence operation. Significantly, the amalgamation had to occur while day-to-day business continued in a busy army.⁴

From the beginning Caughey insisted that there should be only one Chief of Staff HQ FORCOMD. Morrison agreed, clarifying Caughey's responsibilities, accountabilities and authority, and assigning additional staff to him. Caughey would be responsible for the performance of headquarters staff and communicating and enacting Morrison's intentions on the operation of the headquarters and the functioning of FORCOMD. In effect, Caughey would be the first among equals, not only with Brigadiers Wilkie and Sengelman located at Victoria Barracks, but also with Brigadier Mick Moon, COMDT RMC, in Canberra. Moon was responsible for the Army's officer entry and recruit training and for those officer and other rank career courses delivered at Canungra. Caughey would also coordinate the interaction of HQ FORCOMD with other peers who commanded 16

2 Major General D.L. Morrison, 'The Army Training Continuum', LHQ/OUT/2009/X1194355, Land Headquarters, c. June 2009, AWM: Col (OA) papers.

3 Major General D.L. Morrison, 'COMD FORCOMD Directive 45/09, The FORCOMD Operations Plan 2010-2015', 16 November 2009, AWM: Col (OA) papers.

4 Interview with Brigadier S.F. Caughey, 15 July 2010. Interview with Brigadier S. Wilkie, 15 July 2010.

Aviation Brigade, 17 CSS Brigade and Headquarters Regional Training Centres, and the three Regular brigade commanders (1, 3 and 7) when those formations came under command of HQ FORCOMD later in 2009.

A particular challenge for both Morrison and Caughey would be the relationship between HQ FORCOMD and the Reserve 2nd Division.⁵ Major General Craig Williams, COMD 2nd Division, was responsible to Morrison for developing and maintaining the division's contribution to the Army's operational capabilities ('the war') and for generic force preparation ('a war'). The Army Reserve was providing sub-units for garrison duties in Solomon Islands and Butterworth Air Base in Malaysia, and would be taking over garrison responsibilities in Timor Leste in 2010. Decisions would have to be made on how Reserve forces assigned for operations would be trained and certified for joint employment.

Testing the Structure of HQ FORCOMD

In January 2009 the priority lay with confirming the practicality of the recommended model for HQ FORCOMD that Major General Power and key staff, Lieutenant Colonels John Shanahan and Shaun O'Leary, had developed in 2008. Morrison accepted Caughey's advice that external management consultants would not be required.⁶ Caughey and Wilkie decided to 'war game' the recommended model with scenarios, boxed studies and a quick decision exercise with newly arrived and continuing staff in mid-February 2009 to test and 'tweak' the proposed model. Importantly, representatives from HQ 1st Division, HQ 2nd Division, SOCOMD and the three Regular brigades attended. This shared activity would also familiarise staff with new working and functional arrangements. The 'war game' scenarios were based around:

- **The Army's new amphibious operations capability.** Focal question: how will HQ FORCOMD develop, plan and execute the establishment of the marine grouping with supporting capabilities?
- **ATC.** Focal question: is HQ FORCOMD sufficiently well structured to develop, support and manage the ATC?
- **Mass casualty incident.** Focal question: how will HQ FORCOMD manage a mass casualty incident and associated outcomes?
- **Deployment of High Readiness Reserve in deployment cycle.** Focal question: how will HQ FORCOMD manage the deployment of the high readiness Reserve within the deployment cycle?
- **Exercise Talisman Sabre 2013.** Focal question: how will HQ FORCOMD plan, support and develop Exercise Talisman Sabre 2013, including international engagement, to test the DJFHQ role, the effects on the readiness cycle and Foundation Warfighting training?
- **Resource management.** Focal question: are the internal and external linkages of HQ FORCOMD capable of efficiently managing the ATC?

The boxed studies comprised:

- **Boxed Study 1.** Focal question: what are the implications of formations moving between FORCOMD and HQ 1st Division with the same state of command?
- **Boxed Study 2.** Focal questions: DGT is responsible for the delivery of the ATC. Is this viable if exercise planning is situated in G5 staff (plans)? Should the exercise planning team be moved to G3 staff (operations) or G7 staff (training policy and operations)?
- **Boxed Study 3.** Focal questions: if HCD-A is responsible for capability development, should all the LHQ/Training Command projects be handed to HCD-A and G8 staff (capability development) move to the Commander's Advisory Group (CAG) and focus on end-user capability requirements and training integration?

⁵ The 2nd Division commands the Reserve brigades: 4 Brigade in Victoria, 5 and 8 Brigade in New South Wales, 9 Brigade in South Australia and Tasmania, 11 Brigade in Queensland and 13 Brigade in Western Australia.

⁶ Interview with Brigadier S.F. Caughey, 15 July 2010.

As a result of the war game, the CAG was reduced in number and there were other refinements to Power's recommended structure. HQ 1st Division would be the mounting authority for all land forces, less Special Forces, and would certify their readiness for operations in accordance with start states specified by HQ JOC.

For force rotations for enduring operations, the headquarters of the brigade providing the bulk of deploying forces would be the mounting headquarters. Morrison and Caughey would have to make other arrangements for short-notice deployments when the brigade providing the bulk of forces was also providing the bulk of staff and equipment for a deploying JTF HQ.

The war game validated the proposed HQ FORCOMD structure and significantly enhanced its development and implementation. Participants from other formations in the Army provided valuable perspectives. It was an excellent rehearsal for exercising and developing new staff for their forthcoming roles in HQ FORCOMD. There was still work to do, however, on the design and implementation of the ATC and delineating responsibilities between the new HCD-A and HQ FORCOMD.

For her part, Brigadier Wilkie was concerned that participants in the war game were interpreting the amalgamation as subsuming HQ Training Command into LHQ.⁷ Fortunately, Power had anticipated this possibility. In her appointment as DGT, Wilkie would manage all day-to-day operations of HQ FORCOMD through a colonel (operations) and have a strong integrated training policy staff also led by a colonel (G7). When assigned forces were being prepared at short notice for transfer to HQ 1st Division at an agreed point having achieved a specified start state, Caughey would take a more prominent role in directing the main effort of Colonel (Operations) and the operations staff. Wilkie described the arrangements for day-to-day operations between herself and Caughey as 'time-share'.⁸

Amalgamation Process

Once Morrison had agreed to a refined organisation model for his new headquarters, Colonel Peter Short from AHQ and his team conducted a unit establishment review of the proposed HQ FORCOMD to formalise the new structure within the Army. At the same time, APS staff members were reallocated and some staff positions redefined to support the new structure. This proved to be more challenging administratively than allocating military staff to new positions and redefining their duty statements. Combining registry and management functions for personnel, finances and logistic support was both complicated and stressful for some APS staff members who had served in the separated LHQ and HQ Training Command at Victoria Barracks for some time.⁹

Caughey and Wilkie agreed on a sequential and incremental approach to the amalgamation of branches and staff functions. Staff moved branch by branch and function by function one after the other to their new office spaces from early April. The operations staff groups were the last to move and amalgamate in the former Land Command Joint Operations Centre.

This incremental process was a sensible and less disruptive approach compared to moving simultaneously on 1 July and beginning operations as HQ FORCOMD immediately. From April to the end of June 2009 amalgamated staff groups operated in unison in response to inputs from Land Command and Training Command organisations and from AHQ and other organisations while continuing to respond separately to force elements and training establishments.

7 Interview with Brigadier S. Wilkie, 15 July 2010.

8 Ibid.

9 Ibid.

A number of staff groups supported the lines of operation required to fulfil HQ FORCOMD responsibilities:

- G5 – force generation (main effort)
- G4 – logistics
- G1 – personnel capability
- G7 – Foundation Warfighting
- ACOFS – command and control
- G6 – information communications and technology
- G3 – influence and information
- ACOFS – policy and governance
- G5 – force modernisation

In broad terms, G5 was responsible for programming and planning all activities across the lines of operation. G3 was responsible for final planning, tasking and synchronisation for the delivery of all activities.

Formation of the 6th Brigade

Having approved the two models that emerged from the first workshop in May 2008, Lieutenant General Gillespie had then decided to form a Combat Support Group in HQ FORCOMD. The Combat Support Group would consolidate a number of specialist units, previously known as direct command units. These units had their origins in the central management of specialist units known as corps troops and specialist corps commanders and staff groups for artillery, engineers, medical and signals on divisional headquarters. Since the Second World War, many units in corps troops had been disestablished or overtaken by technology and reorganisations to become more modern specialist units such as the 7th Signals Regiment and 1st Intelligence Battalion.

In the 1990s LHQ still had a Commander – Artillery and a Commander – Land Command Engineers with their specialist staff groups, and some artillery and engineer units under command. By the mid-2000s, these positions and staffs had been downgraded or disestablished, leaving some direct command units as ‘orphans’. Units such as the three regional force surveillance units (RFSU) had also become LHQ direct command units, directed by the Colonel (Operations). However, command exercised by a staff officer was clearly sub-optimal.

Initially, the organisers and participants in workshops and consultations in 2008 envisaged grouping direct command units into a Combat Support Group, then a Forces Command Support Group and later a Manoeuvre Support Group that would be commanded by a brigadier. The penultimate title at the end of 2008 was the CS&ISTAR Group. Eventually, its constituent units would be:

- 1st Ground Liaison Group
- 1st Intelligence Battalion
- 2/30th Training Group
- 6th Engineer Support Regiment
- 7th Signal Regiment
- 16th Air Defence Regiment, Royal Australian Artillery
- 19th Chief Engineer Works
- 20th Surveillance and Target Acquisition Regiment, Royal Australian Artillery

- 51st Battalion, Far North Queensland Regiment
- North-West Mobile Force
- The Pilbara Regiment

One of the most interesting and unexpected outcomes of this effort to consolidate and manage these direct command units was the formation of the 6th Brigade. It was an evolutionary process. The founding father was Brigadier Jeff Sengelman, a Special Forces officer who had returned from service as Chief of Staff, US Special Forces, in Iraq in 2008. Sengelman had received a unique insight into the way twenty-first century technology was being integrated into contemporary operations. Major General Morrison interviewed him in late 2008 to seek his views on becoming the senior staff officer at the new HQ FORCOMD who would establish and manage the CS&ISTAR Group.¹⁰

Sengelman accepted the appointment in January 2009. He set out from the beginning to develop the CS&ISTAR Group as a mechanism for the Army to employ twenty-first century technology and aggregate the capabilities of the group's disparate units into a cohesive formation that delivered capabilities for the Army that would be needed for both 'the war', 'a war' and 'the next war'. In particular, Sengelman aspired to provide the Army enhanced ISTAR capabilities comparable to and interoperable with major allies such as Britain and the United States.¹¹

His first objective was to clarify his status. In the past, senior operations staff officers at LHQ and HQ 1st Division had commanded and managed direct command units. Accordingly, commanders of these units had reported to the busy senior staff officers who did not necessarily employ them. This was not a satisfactory or straightforward arrangement. Specialist direct command units, such as the three RFSU, worked more closely with and were more closely aligned to other tasking organisations than the headquarters that managed them. Furthermore, employers of some of these units were not even in the Army (see Figure 19).

Preferring something more coherent, Sengelman sought formation command status.¹² He wanted to be a formation commander so that he could direct the activities of these units meaningfully and argue business cases for enhancement of their capabilities to keep pace with improvements in technology. He wanted a seat at the same table as other brigade commanders in the Army when it came time to negotiate for resources and to synchronise activities.

Figure 19 DCU Tasking Relationships – 2008

Unit	Tasking Organisation(s)
1st Intelligence Battalion	Defence Intelligence Organisation
7 Signals Regiment	Defence Signals Directorate
1 Topographical Squadron	Defence Imagery Geospatial Organisation
1st Ground Liaison Group	RAAF
16th Air Defence Regiment	Operates RBS-70 missiles to protect ships and air bases
20th Surveillance and Target Acquisition (STA) Regiment (raised 2006)	Operates Unmanned Aerial Vehicle (UAV) for overseas JTF
6 Engineer Support Regiment	Brigades in Brisbane and Sydney
Regional Surveillance Units	Border Protection Command

10 Interview with Brigadier J. Sengelman, 29 July 2010.

11 Ibid.

12 Ibid.

Sengelman put his views to Major General Power and his successor, Major General Mike Hindmarsh at HQ Training Command, who had the lead in amalgamating LHQ and HQ Training Command. Both saw the advantages of Sengelman as a formation commander rather than a staff officer commanding disparate units. Following much discussion and conjecture, the CS&ISTAR Group would eventually be renamed the 6th Brigade.

The 6th Brigade was first formed during the First World War, serving at Gallipoli and in France and Belgium on the Western Front, including at the famous and innovative battle of Hamel. By April 1953, it was part of Southern Command. After a period as the 6th Task Force, it reverted to its former identity as the 6th Brigade in 1982. In 1991 it was organised in Enoggera Barracks around the Ready Reserve Scheme, peaking at almost 4000 members. It was disbanded when the scheme was discontinued. Its units were merged with others and reallocated to the 7th Brigade. The 6th Brigade would be re-raised on 1 March 2010 to command the 11 units that had comprised the CS&ISTAR Group.

In July 2009, Sengelman took command of some 3000 personnel serving in 11 units dispersed in 38 locations around Australia with a headquarters staff of seven. His task was to make a 'whole' greater than its disparate and dispersed parts. He planned to have three colonels command the major units and report directly to him. The first would command the Modularised Engineer Force comprising 19 Chief Engineer Works and 6 Engineer Support Regiment and the second would command an ISTAR group comprising 1 Intelligence Battalion, 7 Signals Regiment, 51 Battalion, Far North Queensland Regiment, NORFORCE and The Pilbara Regiment. The third colonel would command a Joint Fires Group comprising 20 Surveillance and Target Acquisition Regiment and 16 Air Defence Regiment.

Sengelman began to align his responsibilities and accountabilities with authority and resources. He had responsibility for the performance of 11 units under his command and was accountable to Major General Morrison. His challenge was to establish his authority when he did not command a headquarters and, therefore, could 'be' but not 'do'.

His first priority was to institute governance and authority. He had to exercise his will over commanding officers who worked for other organisations and were responsive to part-time corps directors. His commanding officers soon accepted that Sengelman would not only lead and guide them, but also assist with their aspirations for enhancing the capabilities of their units and influencing their employment operations in a positive way.

Building the 6th Brigade

From the beginning, Sengelman worked to convince Lieutenant General Gillespie and members of his Chief of Army's Advisory Committee (CASAG) to allocate the resources that his formation needed to modernise and increase the ADF's competitive edge on operations. His experience in Iraq made him a formidable advocate for the introduction of twenty-first century technology into several of his subordinate units.

His approach was to ensure that CASAG members understood the nature of the problem. He would then propose a solution and show how it not only solved the problem but also contributed to the Army's competitive edge. In so doing, he enhanced the modernisation efforts of heads of corps and, in some cases, superseded and exceeded them.¹³ Capitalising on his Special Forces background, Sengelman engaged DSTO and drew on research to justify his arguments for technology upgrades and rapid acquisition of capabilities. He also linked the challenges facing the 6th Brigade to bringing Adaptive Campaigning doctrine to fruition.

13 Interview with Brigadier J. Sengelman, 29 July 2010.

In effect, the formation of the 6th Brigade became a catalyst for wider Army modernisation and adaptation. Brigade commanders welcomed enhanced 6th Brigade capabilities in technical intelligence-gathering, surveillance through UAV, electronic warfare, target acquisition and reconnaissance. The final challenge in 2010 and 2011 was to grow a headquarters and establish the 6th Brigade within the Army's organisation.

During 2010, the 6th Brigade's agenda was focused on:

- the development of joint fires, modular engineer force, ISTARAW and RFSU to support the formations
- the development of inter-agency and air/land integration
- the development of network-centric warfare
- the Army's contribution to the joint development of ISTARAW, joint fires and air/land integration
- the Army's indigenous Aboriginal engagement in terms of conducting Army Aboriginal Community Assistance Program and the development and reorganisation of the RFSU

Retasking HQ 1st Division

Lieutenant General Gillespie gave Major General Mick Slater four broad tasks when he assumed command of HQ 1st Division in January 2009:

- prepare assigned forces for operational deployments and contingencies
- maintain a scalable, deployable joint force headquarters at high readiness
- provide planning support to HQ JOC
- exercise technical control of deployed land forces on behalf of CA

Slater and his headquarters would be the sole mounting authority for land forces deploying on overseas and national operations.¹⁴ Major General Morrison would assign him mounting headquarters, normally the brigade headquarters of the formation providing most of the force elements.¹⁵

Slater would ensure that deploying forces were equipped, trained, prepared, packed and loaded at an agreed point having achieved the directed start state that would include sufficient stocks for sustainment during the OVP.¹⁶ He would be responsible for certifying deploying forces as ready for operations, and those forces returning from operations as ready to return to FORCOMD.¹⁷

14 **Mounting Authority:** the authority responsible to the operational commander (normally CJOPS) for setting the policy direction and standards required to meet the operational commander's readiness requirements for deploying forces, ultimately certifying that force elements are competent for joint employment for particular operations.

15 **Mounting Headquarters:** a headquarters appointed by the mounting authority to ensure that land forces are equipped, trained and prepared in all respects to the specified level of capability and operational readiness for joint employment.

16 **Agreed point:** that place, time or event at which formal control of land forces passes from FORCOMD to HQ 1st Division for the commencement of specific force preparation. It is also the point at which formal control of land forces passes from HQ 1st Division to FORCOMD. It comprises: 1. training levels and standards 2. force structure 3. manning 4. equipment 5. readiness 6. sustainability (OVP).

17 **Certification:** the formal and detailed review of deploying land forces to verify compliance with CJOPS' deployment standards for personnel, equipment and training. COMD 1st Division Directive 008/10, 'Certification of Army Conventional Collective Force Elements and Individuals Prior to Deployment on Operations', 12 April 2010, and COMD 1st Division Directive 009/10, 'Certification of Army Conventional Collective Force Elements and Individuals Prior to Demounting from Operations', 28 April 2010, both in AWM: COL (OA) papers.

Slater divided his tasks into a four-phase cycle to meet his responsibilities:

- Phase 1 – planning
- Phase 2 – MST and certification
- Phase 3 – conduct of operations
- Phase 4 – demount

Phase 1 – planning. For ongoing operations, the planning phase would commence at least 12 months prior to the deployment of land forces on operations. Activities in this phase would include the development of plans during the conduct of conferences, staff visits and theatre reconnaissance to inform the specific force preparation plan. The outputs from this phase would be COMD 1st Division mounting directives that would direct the work of assigned mounting headquarters.

Phase 2 – MST and certification. This phase would begin with the concentration of assigned land forces three months prior to deployment and conclude with the assignment of certified land forces to CJOPS and HQ JOC for employment. Directed Mission Essential Task Lists (METL) would guide training and specify the assessment and training outcomes using customised conditions and standards. Slater would chair a COMD 1st Division Force Preparation Certification Board that would certify land forces as ready for joint employment.

Phase 3 – conduct of operations. This phase would begin as soon as the CDF assigned land forces to CJOPS for employment and would conclude when those forces returned to Australia. During this phase HQ 1st Division would exercise technical control over deployed land forces and closely monitor operational conditions, validate pre-deployment MST and ensure that ‘short loop’ lessons were captured, analysed and immediately incorporated into the specific force preparation of the next rotation of land forces for each operation.

Phase 4 – demount. This phase would begin as soon as individuals and land forces were relieved in theatre and continue until they had been reintegrated into their parent units in Australia. The mounting headquarters would be responsible for ensuring that all individuals and force elements were formally welcomed back to their home locations and reintegrated into garrison routine. The mounting headquarters would complete and certify all post-deployment administration and supervise reconstitution for handover/takeover to FORCOMD at an agreed point and start state.

Land Combat Readiness Centre and 39 PSB

Slater assigned his Deputy Commander, Brigadier Peter Clay, to command the LCRC. Colonel Ash Gunder, Commander CTC in Townsville, and Lieutenant Colonel Clark Smith, CO 39 PSB at Randwick Barracks in Sydney reported to Clay. In terms of tasking, Gunder alternated his rate of effort between training sub-units in Foundation Warfighting and conducting MST and MRE for assigned land forces before deployment to national or overseas operations.

Smith’s role had changed as 39 PSB would now prepare and command individuals for overseas service. His command responsibilities began when individuals were assigned to an operation and ended when those individuals were ready to return to their parent units once all post-tour administration had been completed.

Clay employed Colonel Ross Perot to assist Smith to conduct a training needs analysis and direct the design and development of Training Management Plans for preparing individuals for operations. The new generic and accredited training regime focused on three principal areas:

- conducting operational administration
- enhancing situational awareness
- enhancing individual survivability, including confirming weapons handling proficiency and firing in body armour, advanced medical training and practical explosive hazards awareness/counter-IED training

Maintaining the Short Learning Loop

Brigadier Clay was responsible for maintaining the Army's short learning loop. This involved ensuring that the training and equipping of assigned forces for new and ongoing operations was relevant to meeting the challenges of the current operational environment and anticipated changes. Gunder and his staff at CTC had to maintain situational awareness for 'the war' (current operations) and 'the next war' (contingencies).

In order to anticipate specific force preparation requirements such as maps, cultural awareness training, threat assessments and health risks and countermeasures, the newly appointed SO1 Force Preparation, Lieutenant Colonel Kahlil Fegan, created staff groups called Force Preparation Assistance Teams. These teams focused on assisting land forces preparing for operations in the near region, such as East Timor and the South Pacific, international areas of operation, such as the Middle East and Afghanistan, and minor operations, such as those involving small contingents of UN military observers. He also created a Plans and Certification staff group.¹⁸

Clay formed an Adaptive Cycle Decision Group and an Adaptive Warfare Cell under the direction of Iain Cruickshank, a recently retired lieutenant colonel who had served at HQ 1st Division for a number of years. Cruickshank formed two adaptive warfare teams to validate MST and MRE by visiting overseas operations. Visit reports from adaptive warfare teams would inform MST and MRE for the next rotation of forces.¹⁹

The Way Ahead – HQ 1st Division

In 2009 and 2010, Major General Slater envisaged his headquarters staff and newly formed LCRC developing healthy working relationships. He would coordinate, but not integrate functions. In 2011 he planned to fully integrate LCRC functions with the staff groups of his headquarters.²⁰

Slater envisaged applying a traditional principle of establishing HQ 1st Division (Forward) and HQ 1st Division (Rear). HQ 1st Division (Forward) would be a rehearsed, scalable and deployable HQ JTF. HQ 1st Division (Rear) would be responsible for specific force preparation.

The Way Ahead – FORCOMD

The culminating event and final phase of the formation of FORCOMD would be the planning and conduct of major exercises in 2010 that would rehearse Adaptive Campaigning. Inspired by the 'all arms' innovations that the Australian Corps introduced into the Battle of Hamel in 1918, Morrison decided to embark on a biannual exercise program he called the Hamel exercise series. The first of the series would be conducted in October 2010. Exercise Hamel would be nested in Exercise Talisman Sabre every second year.

The name 'Hamel' harked back to the Australian Corps' first major operation under Lieutenant General John Monash. It comprised the attack on a section of the German line which bulged out in a small salient around the village of Le Hamel, north-east of Villers-Bretonneux. Preparations for the attack were undertaken with the extreme thoroughness and elaborate care that characterised Monash's approach.

The Battle of Hamel was fought on 4 July 1918 and is famous as a model for an 'all arms' battle. A broad array of other arms – tanks, artillery, machine-guns and communication units – supported an infantry attack. The action at Le Hamel was a brilliant success and the battle was over in around

18 Interview with Lieutenant Colonel K. Fegan, 5 August 2010.

19 The first two adaptive warfare teams would deploy to Solomon Islands and Afghanistan in May 2010.

20 Interview with Major General M.D. Slater, 5 August 2010.

90 minutes. All objectives were taken and more than 1600 Germans were captured. A feature of the Le Hamel battle was the performance of a new generation of British tanks and the use of No. 3 Squadron, Australian Flying Corps, to drop ammunition to Australian troops by parachute.

Australian innovation and adaptation had characterised the Battle of Hamel in 1918. Lieutenant General Gillespie and Major General Morrison and the other founding fathers of the Adaptive Army initiative hoped that Exercise Hamel, conducted over 100 years later, would emulate these attributes and mark the end of the beginning of the Army's most significant reorganisation for almost 40 years.

Summary

Over three years the Army had concentrated its energies on transforming itself into an adaptive organisation, firmly focused on preparing and delivering land forces, contingents and individuals for joint employment. The changes formulated in late 2007 and thoroughly investigated through a series of collaborative workshops in 2008, were fundamental and profound. They not only constituted a significant restructuring of organisations, but also stimulated a new thinking that was informed by adaptive organisational theory and guided by the capstone doctrine *Adaptive Campaigning*, released in September 2009.

Brigadiers Caughey and Wilkie at Victoria Barracks in Sydney brought together two headquarters with quite different compositions and operating philosophies. Their work was facilitated by the efforts of Major General Ash Power and those who assisted him in 2008. The use of a 'war game' in February 2009 achieved the two objectives of bringing fresh eyes to the process and bonding new and continuing staff in the common purpose of developing optimal structure, processes and procedures. Morrison's comprehensive directives for training and operations integrated the Army's individual and collective training processes for the first time and focused all training and performance evaluation on preparing for operations.

Brigadier Jeff Sengelman had a very different task ahead of him in implementing change in 2009. By force of personality and astute advocacy, and working himself and his staff hard, he formed his disparate and widely dispersed units into a twenty-first century formation. From miscellaneous units unused to working together and a headquarters unused to employing them tactically, Sengelman aggregated their technology and operational capabilities to contribute to the effectiveness of Australian land forces.

Major General Mick Slater implemented change through a two-phase process. His task was to transform a headquarters used to commanding and directing brigades into one that would simultaneously rehearse for its own deployment and prepare land forces for employment. He used 2009 and the first half of 2010 to consolidate and coordinate. In 2011 he would integrate these two functions into a preparatory platform for land forces and a high-readiness deployable HQ JTF.

The Culmination of the Beginning: Exercise Hamel 2010

The year 2008 had marked a period of analysis and decision. The year 2009 was to be characterised by reorganisation. The year 2010 would feature a series of culminating events – the end of the beginning of the Adaptive Army initiative. In 2009, AHQ was divided into a staff division led by the DCA, Major General Paul Symon, who would manage the Army on a day-to-day basis, and a separate division led by newly promoted Major General John Caligari, entitled Modernisation and Strategic Planning Division. Caligari's division would identify the aiming mark for Army's modernisation through analysis and concept development.¹

On 1 July 2009, HQ FORCOMD under Major General David Morrison assumed command of 85% of the Army – the most significant centralisation of command since General Sir Thomas Blamey commanded all of Australia's land forces for the Pacific campaign in the Second World War. Major General Mick Slater reorganised HQ 1st Division to prepare and rehearse land forces, contingents and individuals for operational service and also to maintain a deployable and scalable HQ JTF. Brigadier Jeff Sengelman raised the 6th Brigade, a high-technology, specialist formation.

With the successful establishment of these new structures by Lieutenant General Ken Gillespie and his generals in 2009, the challenge was now to embed the Adaptive Army initiative's culture and ethos in the Army in an enduring way. The Army 21 initiatives under Lieutenant General John Sanderson, CA in the mid-1990s, had not survived beyond his tenure. The Defence Efficiency Review had emasculated AHQ during his period of command.

Gillespie did not want history to repeat itself. New Adaptive Army structures, command and control arrangements, new processes and procedures, had to deliver on their promise in 2010 before the government recast senior ADF leadership positions in mid-2011.

The culminating events in 2010 were:

- the Army's new engagement with modernisation and capability development processes in Defence under Caligari

¹ Major General J.G. Caligari, Presentation to Land Warfare Conference, November 2010, AWM: Col (OA) papers.

- the design, development, conduct and evaluation of Exercise Hamel 2010 (Hamel 10) under Morrison
- the synchronisation of specific force preparation, rotation and planning functions for anticipated and current operations under Slater
- the fielding and testing of the 6th Brigade's capabilities under Sengelman

In short, Caligari prepared for 'the next war', Morrison prepared for 'a war', Slater prepared for 'the war'; and Sengelman developed the Army's technological competitive edge for all three 'wars'.

Notwithstanding the complexity of the challenges that faced Symon, Caligari, Slater and Sengelman in 2010, and the hard work required to meet those challenges, Hamel 10 was the most important and significant culminating event and the prime means to inculcate the Adaptive Army initiative into the Army in an enduring way. A failed or flawed Hamel 10 would represent a major setback. If the new elements and arrangements of the Adaptive Army initiative did not mesh seamlessly in the field during Hamel 10, the benefits of the Adaptive Army initiative would be open to question. Hamel 10 also had to demonstrate that the Army was meeting its primary obligation to the Australian people – to protect national sovereignty with land forces capable of joint land combat.

Problems with being prepared for 'A War'

For over ten years the Army had continuously prepared forces for a high tempo of operations that had been – and were continuing to be – conducted against insurgents at the lower end of the spectrum of conflict rather than a near-peer or a peer enemy that might threaten the Australian mainland. This understandable focus on 'the war' had reduced formation-level warfighting training opportunities and degraded Foundation Warfighting skills for the defence of Australia – 'a war'. There were also concerns that the Army's individual training regime – and the proficiency of junior leaders and small teams – was in a state of flux because of changes to doctrine and long periods of employment on low-intensity stabilisation operations and regional garrison duties. In short, the Army's junior leaders and small teams were not ready for battle.

The CTC and CAL had collected evidence of degradation in the Army's capability and capacity to conduct joint land combat.² The CTC provided empirical evidence of gaps in the basics at individual, small group and combat team levels.³ In 2009, CTC staff had recorded performance gaps in:

- **Battle basics:** individual and small group fire and movement, weapon handling, personal and group protection measures and the application of Standard Operating Procedures (SOP)
- **Junior leaders:** orders, situational awareness and passage of information, comprehension and application of SOP, planning, rehearsals and fault-checking, including checking degrees of weapon readiness
- **Combat team operations:** combined arms cooperation, situational awareness and passage of information, planning, orders, rehearsals and checking, comprehension and application of SOP and TTP, force protection and casualty evacuation
- **Command posts:** situational awareness, passage of information, reporting and information management, and integration of specialist staff and targeting, intelligence, surveillance and reconnaissance (ISR) capabilities

CAL identified performance gaps in soldier skills, joint land combat and other aspects of Adaptive Campaigning doctrine:

² 'Data Collection Related to Achieving the Commander's Intent', Annex B to COMD FORCOMD Post-Activity Report, Exercise Hamel 2010, 23 November 2010, AWM COL (OA) papers. Joint combat is defined as the ability to conduct sustained close combat against a recognisable enemy for a specific purpose.

³ 'Extract from CTC 2009 Trends Report of Feb 10', Enclosure 4 to Annex B to Major General D.L. Morrison, 'Exercise Hamel 2010 Post-Activity Report', 23 November 2010, AWM: Col (OA) papers.

- **Soldier skills:** orders, comprehension and communication of commander's intent, fault correction by junior leaders and basic fieldcraft
- **Joint land combat:** use of offensive support and air assets, amphibious operations, awareness and counter-IED training, interoperability with other government organisations and NGOs, passage of information, liaison, planning inclusiveness, PR, supply chain management, planning health support and casualty treatment and evacuation, ISR fusion process and employment of UAV
- **Adaptive campaigning:** cultural awareness, indigenous capacity building (training, mentoring and partnering with patience), detainee operations and subsequent detainee management, employment of females in culturally effective ways, winning trust and respect of local people, crowd control and population protection, combat net radio procedures, understanding and applying Rules of Engagement (ROE), population support (capacity building, development of local infrastructure, planning and delivering internally displaced personnel and refugee support), and information actions (employment of CIMIC teams, knowledge and application of information and counter-information operations)

The challenge for Brigadier John Frewen, the Hamel 10 Exercise Director, and his staff was to begin rectifying ten years of degradation of the Army's ability to apply firepower and manoeuvre to defeat modern, well-trained and equipped enemy land forces. Hamel 10 had to verify problem areas and improve performance through putting officers and soldiers under pressure in realistic exercise scenarios and events. Helpfully, CAL and CTC staff had made recommendations on the training and testing required, and how to evaluate success in closing performance gaps.

It was clear to Frewen from the beginning that time, environmental and resource constraints for Hamel 10 would only allow him to begin the process of closing these gaps. He anticipated that Colonel Max McIntyre and his G7 staff at HQ FORCOMD would have to design Hamel 11 to continue the process of preparing the Army for joint land combat. Indeed, it might take several Hamel exercises to overcome the degradation of Foundation Warfighting skills that had occurred over the past decade.⁴

The Road to Hamel

In November 2009, Morrison initiated what he called 'The Road to Hamel', his highest priority after supporting current operations.⁵ His staff at HQ FORCOMD conducted an initial planning conference in early December 2009 and began developing an implementing directive and a concept document.

Importantly, the planning and coordination of Hamel 10 over the coming months would be a solid test of the capabilities of a newly amalgamated HQ FORCOMD under pressure. Each staff branch would have to maintain its day-to-day management responsibilities for the ATC while concurrently planning and preparing the Army's largest field exercise in recent years. This would involve numerous coordination and planning conferences and the production of a suite of concepts, plans, instructions and orders.

In 2010, Morrison mobilised FORCOMD for 'a war'. He and Frewen expected Hamel 10 to test and energise all levels of command in the Army.⁶ It was a unique opportunity for over 6000 personnel to live and operate for several weeks in an austere and demanding environment, applying their core military skills and knowledge under pressure. It was the Army's most significant investment in a major field exercise for a decade. Hamel 10 represented the first in a series of annual capstone

4 Interview with Brigadier J.J. Frewen, 3 December 2010.

5 Major General D.L. Morrison, 'Information Brief for CA, HQ FORCOMD, Adaptive Army Quarterly Return as at 1 Feb 10,' 16 February 2010, AWM: Col (OA) papers.

6 Major General D.L. Morrison, 'AMPORD 1 to OPORD 10.11, COMD FORCOMD Implementing Directive 05/10, Exercise Hamel 2010', 16 February 2010, AWM: Col (OA) papers.

exercises designed to train, test and certify the Ready brigade in the force generation cycle – the Army's primary obligation to government.⁷

A significant feature of Hamel 10 was the synchronisation of the efforts of the training establishments of the former Training Command in support of the collective training of the formations of the former Land Command.⁸ Personnel and assets from across FORCOMD combined to support the planning and conduct of the exercise. Thus it exemplified the unity of effort and effect for force generation that the founding fathers of the Adaptive Army initiative had envisaged. Major General Slater and HQ 1st Division would also conduct a preparedness activity, Exercise Pozieres, and act as Blue Force higher command for the early phases of Hamel 10.

Hamel 10 would begin the new force generation cycle by training, evaluating and certifying a brigade group. It would also begin to remediate the degradation of Foundation Warfighting skills caused by the Army's continuous participation in overseas stabilisation operations over the past ten years. In addition it would contribute to future technological development. The climax of Hamel 10 would be a large-scale live-firing exercise that would showcase the Army's kinetic punch in conjunction with the Air Force. Finally, Hamel 10 would test Morrison's span of command and put pressure on his newly amalgamated headquarters.

Designing Exercise Hamel 2010

Naming the exercise 'Hamel' reflected a desire to emulate the innovative features of the brilliantly planned and executed Battle of Hamel in the First World War. The Australian Corps reached the peak of its fighting performance as a result of the Battle of Hamel and would go on from 8 August to participate in a series of decisive advances until Germany surrendered on 11 November 1918. Ninety-two years later, in November 2010, the Ready brigade had to demonstrate that it was ready to fight and win in battle and assist in defeating insurgencies.

The concept of operations for Hamel 10 was based on land force projection. A brigade group would plan and prepare at its home bases and then deploy by sea, air and road to an area of operations. Considerable emphasis was placed on the realistic sustainment of deployed forces, one of the historical weaknesses of Australian military force projection.

The employment of forces would begin with forced entry followed by simulated joint land combat and a contest with insurgents operating within the local populace. Concurrently, the RBG, embarked on HMAS *Manoora*, would conduct a forced entry, followed by an emergency evacuation of Australian nationals, accompanied by the delivery of humanitarian aid – the RBG's most likely short-notice overseas contingency.

Brigadier Frewen directed assigned staff at HQ FORCOMD to design and develop Hamel 10 around the five lines of operation of Adaptive Campaigning.⁹ He had three objectives:

- certify the Ready brigade (3rd Brigade)
- remediate the degradation of joint combat skills
- facilitate experimentation and technology development

Frewen had ten months to plan and prepare 6500 personnel – 40% of the deployable Army – for a six-week exercise in the field near Townsville and areas further north.

7 'The principal task of the ADF is to deter and defeat armed attacks on Australia by conducting independent military operations without relying on the combat or combat support forces of other countries.' (Force 2030 para 7.2).

8 Support for the exercise would come from RMC, DCSTC, CATC, ALTC, JCTC, JMOVGP and DSTO.

9 Adaptive Campaigning lines of operation are: joint land combat; population protection; information actions; population support; and indigenous capacity building.

Certification

The first Hamel exercise in 2010 focused on the 3rd Brigade achieving fitness for employment as a JTF.¹⁰ The 3rd Brigade would be tested in its conduct of combined and joint operations that integrated joint air/land capabilities, as well as the full range of combat support, intelligence, surveillance, target acquisition, reconnaissance and electronic warfare (CS&ISTAREW) effects. Thus, Hamel 10 would evaluate and certify HQ 3rd Brigade and its organic and assigned battlegroups and sub-units to specified training standards 7B and 6B respectively.¹¹

Importantly, Hamel 10 was about generic force preparation, not specific force preparation. Morrison would certify the 3rd Brigade at Standard 7B and 6B for collective capabilities. It would then be the responsibility of Major General Slater and LCRC to certify the achievement of Standard 7A and 6A after assigned elements from the 3rd Brigade had completed MST and MRE under his supervision.¹² Thus, Morrison prepared land forces to meet the CA's expectations for joint employment and Slater prepared land forces to meet the expectations of CJOPS.

The Hamel 10 scenario capitalised on the scenario used by HQ 1st Division for the Exercise Pozieres series. It related to an internal conflict within a state that was supported covertly and overtly by a neighbouring state seeking to destabilise its neighbour in pursuit of its own strategic agenda. Thus, the 3rd Brigade had a simulated contest with near-peer enemy forces from the state that was destabilising its neighbour, and also with insurgents, sponsored by that state, who were operating in its neighbour's territory. Guided by Adaptive Campaigning doctrine, the 3rd Brigade would engage in joint combat while simultaneously conducting population protection, population support and information actions.

Closing the Performance Gaps

Frewen and FORCOMD staff developed testing events to verify the extent of the gaps that CTC and CAL reports had identified over the past four years and to remedy as many as possible while also evaluating performance.¹³ The challenge would be to combine the mentoring that was a feature of the CTC approach to preparing and rehearsing units for operations, and the objective evaluation that was a feature of accountable training systems.

In addition, there had to be some adjudication of exercise events to maximise training value, analyse error and acknowledge best practice. In the past, a Chief Umpire would have been appointed and assigned a contingent of umpires who would supervise, adjudicate and report on exercise activity in accordance with a Main Events Schedule. For Hamel 10, Morrison appointed a Chief Evaluator and assigned him an Observer Trainer Group (OTG) that combined the roles of observer-trainers and umpires/adjudicators, as well as safety and environmental monitoring staff, in a single organisation. Frewen decided to co-locate the Chief Evaluator and HQ OTG with the staff controlling the exercise (Exercise Control) at the Ralph Honner Battle Simulation Centre in Lavarack Barracks, Townsville, in order to synchronise mentoring and training functions with evaluation, safety and environmental management.

10 Major General D.L. Morrison, 'Exercise Hamel 2010 Exercise Concept Document', 16 February 2010, AWM: Col (OA) papers.

11 **Level 7B:** JTFHQ/brigade/division-sized formation capable of commanding and coordinating a joint operation, having been trained, practised and evaluated, but not under operational conditions, in the application of the collective skill or technique, and ready for deployment.

Level 6B: Battlegroup capable of operating in a brigade context, including utilising joint assets, having been trained, practised and evaluated, but not under operational conditions, in the application of the collective skill or technique, and ready for deployment.

12 The difference between 7B and 6B and 7A and 6A encompassed the additional effort to train and prepare force elements under simulated operational conditions derived from an analysis of their anticipated employment in a new area of operations, and the nature of the hostile forces that would oppose them.

13 Interview with Brigadier J.J. Frewen, 3 December 2010.

The observer-trainers would be busy. Their roles and tasks were to provide advice and mentoring for commanders and staff to achieve their evaluation, certification and lessons identification tasks. Concurrently, they would monitor safety, direct compliance with safety procedures and observe and adjudicate contests, provide performance feedback and monitor the impact of exercise activities on the environment as agents of the Chief Environmental Officer.

Thus, Morrison and Frewen designed Hamel 10 to test whether the Australian Army was still 'brilliant at the basics', hoping that every participant, from brigade commanders to private soldiers, would find it professionally rewarding. Hamel 10 would be the first in a series of annual field exercises that would validate the new individual-collective training continuum (ATC). For the first time, training levels and standards and the use of METL and land combat operational tasks would drive the conduct and evaluation of a large-scale field exercise.

Experimentation and Experiential Learning

Staff from DSTO embraced Hamel 10 as an opportunity for experimentation and innovation with the results providing important information for Major General Caligari and his staff. It was also designed as a test bed for emerging capabilities, particularly those associated with the 6th Brigade.¹⁴ The Army's new Armed Reconnaissance Helicopter (ARH) would also be exercised in support of a brigade group for the first time.¹⁵ Hamel 10 was designed to test the capabilities, processes and procedures of a newly reorganised combined arms battlegroup, the aviation combat team, combat health platoons and ISTAR/EW fusion teams.

The combined arms battlegroup was of particular interest as it represented the Army's new kinetic punch. It came from the 1st Brigade in Darwin and comprised HQ 1st Armoured Regiment, under the command of Lieutenant Colonel David Graham, who directed the operations of a tank squadron, an infantry mechanised company, an engineer troop and a medium gun battery of eight guns from 8/12 Medium Regiment supported by ARH from the 1st Aviation Regiment.

The precedents set in 2010 for the Hamel series would represent a means for Caligari and his staff to observe experimentation with new technologies and identify gaps in capabilities that the Army Modernisation Steering Group needed to examine. An analysis of lessons and technology, while bearing in mind the legacy capabilities that would be in service for ten to 30 years, would provide vital information for the Army capability development program.¹⁶

While certification was the primary focus for Hamel 10 because it was a fundamental output for the force generation cycle, the Hamel series would reintroduce experiential learning into Army training. While competency-based individual training specified learning outcomes and prescribed training processes meticulously, Hamel 10 was a learning activity that was no less specific in its description of intended learning outcomes, but was far more free-flowing and challenging for participants.

The focus for learning was on simulating operational conditions that included uncertainty, incomplete information, information overload, time constraints and the physical and mental pressures of modern operations. While all activities were to be conducted within strict safety guidelines and minimise impact on the environment, Hamel 10 orchestrated opportunities for individuals, groups and units to experience the fog of war and test their resilience to its impact.

14 Namely CS&ISTAREW.

15 Twenty-two Eurocopter Tiger helicopters replaced the Bell 206B-1 (Kiowa) and UH1-H (Iroquois) gunship helicopters with a new reconnaissance and fire support capability.

16 Major General J.G. Caligari, Land Warfare Conference Presentation, December 2010, AWM: Col (OA) papers.

Conduct of Exercise Hamel

During the period 2 October–11 November 2010, the 3rd Brigade (Blue Force) deployed with its integral combat and logistic support units to the High Range Training Area, located inland from Townsville, to simulate operations against conventional, highly capable combined arms, near-peer forces, and insurgents who were able to operate in support of conventional forces within the local populace (Red Force). The exercise culminated in a live-firing activity for each of the 3rd Brigade's organic and assigned battlegroups and other force elements.

From 2 to 9 October, HQ FORCOMD staff under Colonel James Burns, Assistant Chief of Staff at HQ FORCOMD, commanded the staff and established Exercise Control at Lavarack Barracks, Townsville, while deployable elements from 17 CSS Brigade under Colonel Jim Evans established a mounting base there and a forward operating base at Macrossan, inland from Townsville. Brigadier David Creagh, Commander 17 CSS Brigade, and his staff conducted RSO&I and force induction training for all participants, including contingents from the New Zealand Defence Force and the United States Marine Corps.

After concentrating in Townsville, forces deployed into the area of operations by road, sea and air via the forward operating base at Macrossan during the period 10–13 October 2010. For the next two weeks, the 3rd Brigade group (two battlegroups) secured its area of operations and conducted joint land combat at brigade level and stabilisation operations.

While the RAN proved unable to assign HMAS *Manoora* to Hamel 10, the RBG and Air Combat Team pressed on, conducting an emergency evacuation operation and supporting the population with humanitarian assistance in the Innisfail and Tully area in Far North Queensland. As part of the deployment for these operations, 3 RAR conducted a parachute jump at Charters Towers, the Airborne Combat Team Certification jump. HQ 3rd Brigade commanded three deliberate battlegroup-level activities and several air-mobile operations, culminating in a brigade attack that incorporated urban assault and clearance.

The culmination of Hamel 10 was an all-arms live-fire exercise. Following two days' preparation, the 3rd Brigade group crossed an obstacle and broke into an enemy main defensive area while suppressing depth positions with artillery, mortars and close air support. This was the modern equivalent of the Battle of Hamel in 1918. The Army demonstrated its ability to synchronise firepower and manoeuvre to destroy an enemy force dug in on Australian soil – the Army's first and most important obligation as specified in the 2009 Defence White Paper.

Outcomes

Hamel 10 confirmed that large-scale, formation-level exercises were the most effective way to enhance and measure Foundation Warfighting skills across the bulk of the Army and its individual and collective training bases. The exercise had effectively replicated individual and collective operational requirements in a realistic, complex and demanding environment. Hamel 10 satisfied Gillespie's obligation to government for a brigade group to be certified and ready for rapid deployment while land forces participated in a range of operations overseas at the same time.

While logistics support to Hamel 10 was largely successful, there had been some degradation in corporate knowledge of how to support a large-scale exercise and simultaneously train and evaluate supply chain management to deployed forces. Indeed, areas for improvement, such as early involvement of logistics specialists in planning and early articulation of supply chain management arrangements for Hamel 10, applied equally to the sustainment of deployed forces. Notwithstanding these challenges, the employment of 17 CSS Brigade and the forward deployment of its Force Support Group had worked well.

The exercise scenario had proved challenging. It reflected complex warfighting on paper, but proved difficult to enact. Despite its whole-of-government scenario, Hamel 10 lacked representation from Defence, service and joint agencies such as HQJOC, SOCOMD, Defence Intelligence Organisation, Defence Imagery and Geospatial Organisation, Navy vessels and service aircraft. Representation from other government departments and agencies, such as the Department of Foreign Affairs and Trade, AFP, AusAID and NGOs was minimal. Importantly however, the successful conduct of Hamel 10 had begun to stimulate interest from these departments and agencies in participating in Hamel 11.

One of the most important outcomes of Hamel 10 was the production of a list of observations confirming and certifying competency, and a longer list verifying where there were gaps between current proficiency and required competence in Foundation Warfighting. The exercise complemented, confirmed and categorised empirical evidence from CTC and CAL on the Army's proficiency and clarified where there was room for improvement.¹⁷ In Morrison's words, Hamel 10 'provided the opportunity to state the requirements for collective training, and to measure the current state of the associated standards.'¹⁸

The exercise proved that there had been some degradation in basic soldier skills and infantry minor tactics – the Australian Army's reputation of being 'brilliant at the basics' and having the best junior leaders and small teams in the world would need to be re-established. Junior leaders not did not fully understand and apply the planning process, deliver clear orders and check faults or rehearse and conduct thorough battle preparation.¹⁹

The Officer Training Continuum would also need to be updated. There were deficiencies in joint land combat at the battlegroup and combat team levels in applying planning processes, using planning tools, delivering effective orders and synchronising supporting arms and services. There were also problems with the passage of information, situational awareness and battle tracking along the chain of command.

While Hamel 10 had demonstrated that the Army needed to improve its basic skills, it also provided an all-important baseline from which to improve. Army training establishments now had clear direction on where and when to focus remedial training, redevelop training management plans and deliver training more effectively. Colonel Max McIntyre, G7 at HQ FORCOMD, and his staff now had baselines to build on and gaps to close in the ATC. The focus of Hamel 11 would be to apply lessons derived from Hamel 10 in order to improve the Army's competence in Foundation Warfighting. This process would perpetuate the medium learning loop envisaged by the founding fathers of the Adaptive Army initiative.

The observer-trainers from both the training establishments and combat units benefited from participation in Hamel 10. Those responsible for individual training could study the application of individual and small team skills during demanding collective training. This exposure to the practical application of skills currently taught in Army training establishments prompted revisions to curricula that would make individual training more relevant to Foundation Warfighting. In addition, personnel from combat units could observe these units in an operational setting. This was valuable experience for updating corps skills and knowledge.²⁰

17 Lessons from Hamel 10 were derived from three sources. Commanders and key supporting staff conducted a review and the observer-trainer network compiled observations based on independent evaluation, employing the CTC methodology for reporting performance against METL. In addition, the 3rd Brigade group commanders and staff provided self-assessments based on their experiences.

18 Major General D.L. Morrison, 'Exercise Hamel 2010 Post-Activity Report,' 23 November 2010, AWM: COL (OA) papers.

19 Ibid.

20 Ibid., Annex F, 'Exercise Planning and Conduct Lessons', p. 4.

Other important outcomes of Hamel 10 included contributions to Army modernisation and doctrine. The exercise had been a test bed for a number of new capabilities and a vehicle for experimentation. These capabilities, such as the ARH and UAV, had been trialled and their use and effects analysed carefully. Specialist doctrine had also been tested and would need to be modified. For example, Joint Air Attack Teams had deployed and been able to summon a variety of aircraft and launch them into the fight. As a result, there would be changes to doctrine to streamline close air support TTP. The deployment of All Source Fusion Cells for the first time revealed gaps in doctrine that would need to be closed.

Live-fire exercises had not only combined the firepower of the combat arms in a common purpose, but also summoned and employed the firepower of the Air Force. Hamel 10 had upgraded the Army's ability to simulate the modern battlefield and identified the need for increased battle noise and other simulation and instrumentation capabilities.²¹

In terms of span of command, Morrison's previous concerns had been allayed by what he had seen during Hamel 10. He had found engaging, talented and highly professional subordinate commanders and the Road to Hamel had been exceptionally invigorating. Gaining mutual agreement on priorities, allocation of resources and expected standards had proven remarkably straightforward. He had then allowed his subordinates to fight the battle, reporting success or modifying plans if problems arose. The Road to Hamel had embedded directive control in FORCOMD and it had worked well.²²

In many ways Hamel 10 encapsulated what a modern army must do to remain competitive and was characterised by four salient features:

- The synchronisation of individual and collective training with a force generation cycle that focused effort and clarified priorities and resource allocation, while firmly connecting training to operational performance
- The integration of emerging technology with evolving contemporary practice. While some experimentation created artificial episodes during the exercise, this was a reasonable impost for an increase in comparative advantage in the longer term
- Hamel 10 involved 40% of the deployable Australian Army in an annual culminating training and evaluation experience in which new technology, new learning from operational experience and new doctrine could be applied simultaneously
- The emphasis on evaluation and on the identification and application of lessons embedded continuous improvement, transferred many skills and much knowledge and balanced the training demanded by strategic guidance with the training required for contemporary operations and contingencies

Finally, Hamel 10 combined many of the aspirations of the Adaptive Army. It was the culmination of three years of hard work conceptualising, analysing, deciding on, and then implementing change. It exercised revised Army high command arrangements with new responsibilities and roles. The exercise gave expression to the new Army learning environment and knowledge management crucial to the success of the training continuum. It addressed the modernisation imperatives required to achieve continuous improvement, as well as adaptation to changes in threats to Australia's sovereignty and national interests. It specified the performance and technological baseline from which Australian land forces could build improved performance – the genesis of the adaptive mindset. The lessons identified during Hamel 10 would drive numerous reforms over the coming years. Hamel 10 was the culminating event that placed the Army in a permanent state of adaptation.

21 Interview with Brigadier J.J. Frewen, 3 December 2010.

22 Major General D.L. Morrison, 'Forces Command', United Service, Vol. 61, No. 4, summer 2010.

Audit of the Adaptive Army Initiative – Improvements and Challenges

The efficiency of Australian military force projection is a matter of national importance and reputation in peacetime, and national survival in war. The Adaptive Army initiative represents the most important reorganisation of the Army since the 1970 Hassett Review. It is also the most substantial reform of the functions and processes for projecting Australian land forces since the 30-year evolutionary introduction of joint command and control arrangements.

It is vital to examine the impact of the Adaptive Army initiative within the overall context of Australian joint military force projection. The orthodoxy that the three services could and should operate independently has long been consigned to history. The current and future orthodoxy is that the three services must combine seamlessly for operations across all the functions of force projection. How has the Adaptive Army initiative improved the Army's participation in joint cooperation to enable these functions and what challenges still lie ahead for Australia to be competent in self-reliant military force projection?

Audit Steps

This audit of the Adaptive Army initiative will follow three steps:

- examination of the ADF's remediation of historical weaknesses in force projection
- examination of how far the Adaptive Army initiative has comprehended this remediation and grouped organisations with responsibilities, accountabilities, authority and resources to strengthen preparation and projection of land forces
- a summary of improvements and continuing challenges

Remediation of Historical Problems with Land Force Projection

The end of the Cold War saw the services reinforce their preference for continuing to exercise and operate autonomously. Joint exercises in Australia struggled to harness and combine the capabilities of the three services which strongly resisted joint arrangements for their command, employment and sustainment. This resistance increased risk to land forces during several post-Cold War operations.¹

1 See Breen, *Struggling for Self Reliance*.

Over time the ADF resolved some systemic weaknesses in Australian military force projection. But the Army had yet to accept some of this remediation, particularly in the new joint command and control arrangements for operations.²

Reform of Joint Command and Control

The culmination of the steady reform of ADF command and control from the mid-1980s was the establishment of joint arrangements under CJOPS and HQ JOC (deployment, command, employment, force protection and redeployment) and CJLOG and JLC (sustainment) in the early and late 2000s.³ Service chiefs retained responsibility for generic and specific force preparation as well as the rotation and reconstitution of forces to maintain operational tempo.

Arrangements for sustainment of deployed land forces did not align responsibility, accountability, authority and resources. The continuing challenge for CJLOG is not just to harness and coordinate the surge of logistic support and the goods and services required to support pre-deployment preparations from the services and DSG (base services) for specific force preparation, but also to harness each service's deployable logistic support assets to establish and operate supply chains to sustain deployed joint forces.

The commercialisation of logistic support and base services in the 1990s introduced additional challenges for those ADF units preparing for operations and establishing supply chains. Extant and expedient Defence contractual arrangements for goods and services had to incorporate a surge capacity to support increased logistic, administrative, procurement and training activities and base services.

Time Constraints

Since the early 1990s, governments have given the ADF an average of four weeks – sometimes less – to prepare and deploy joint task forces offshore. Fortunately, the crisis management machinery in government and in the ADF has improved since the 1990s. An important factor in this improvement was the admission of the CDF as a member of the National Security Committee of Cabinet. From the early 2000s, the then CDF, General Peter Cosgrove, began convening the Strategic Command Group by video link in order to facilitate the efficient passage of information and concurrent planning from the strategic down to the tactical levels of command.

A continuing challenge for the CDF is to assign forces to CJOPS and authorise the service chiefs to begin specific force preparation while Cabinet deliberates and approves offshore deployment of military forces – a sensitive political decision. The specific challenge for HQ JOC is to articulate the required start states and agreed points for assigned land forces in sufficient time for their preparation prior to deployment. HQ JOC's other major challenge is to receive prepared forces from the services in time for pre-deployment joint rehearsal with deploying JTF headquarters.

Lack of Rehearsal

In the 1990s there was little or no rehearsal of specific force preparation or joint sustainment operations. Joint exercises since then have reflected contemporary contingencies and there is now joint doctrine for pre-deployment operations.

The continuing challenge is to rehearse pre-deployment operations for land forces and their offshore sustainment and command arrangements with newly raised JTF headquarters. In 2011 HQ 1st Division did not have habitual links or contingency protocols with enabling organisations such as JMOVGP, JLC or DSG for this type of rehearsal.

2 Ibid., Conclusions.

3 For the evolution of ADF joint command and control arrangements in the 1980s see Bob Lowry, *The Last Knight: A Biography of General Sir Phillip Bennett AC, KBE, DSO*, Big Sky Publishing, Newport, 2011, Chapter 8, and in the 1990s, see David Horner, *Making the Australian Defence Force*, Oxford University Press, Melbourne, 2001, Chapters 2–5.

Reconnaissance and Deployment

Reconnaissance for post-Cold War operations prior to 2007 was often conducted hastily and too late to inform specific force preparation. In 2007, HQ JOC became responsible for joint planning and conducting joint reconnaissance. COMD 1st Division's challenge has been to receive timely approvals from HQ JOC for land force reconnaissance and the inclusion of specialists such as engineers, logisticians and intelligence personnel.

In the past, the Army's logistic and movement support systems have not synchronised sufficiently well to enable efficient loading of ships. The introduction into service of LPA HMAS *Kanimbla* and HMAS *Manoora* increased capacity, but not synchronisation of delivery of stocks and loading. The introduction into service of two LHD, HMAS *Canberra* and HMAS *Adelaide* in 2014 and 2015 respectively, will no doubt increase capacity and efficiency, but not necessarily synchronisation.

For deploying land forces the challenge continues to lie in understanding what to load, particularly if reconnaissance has not informed specific force preparation. Director General Support at HQ JOC and Director General Supply Chain Management at HQ JLC and JMOVGP must possess a clear understanding of what should be loaded and must then synchronise stock delivery with loading plans.

Command of Ways and Means

In post-Cold War operations prior to 2007, JTF commanders had limited control over the vessels and aircraft required to deploy and sustain their forces offshore. The CDF assigns CJOPS the means (sea, air, land) to deploy and resupply land forces. Director General Support, HQ JOC, in conjunction with JMOVGP and Director General Supply Chain Management, HQ JLC, is responsible for deployment and resupply. The ADF Air Operations Centre is located at HQ JOC.

The services exercise technical command of assigned force elements overseas. This parallel chain of command and continuing role in single-service sustainment, particularly in spare parts resupply, can sometimes constrain joint employment of assets by JTF commanders who are responsible and accountable for operational outcomes.

Disconnections in Sustainment

The services continue to manage parallel supply chains to offshore operations as part of exercising technical command of deployed force elements. For example, maritime and Air Force units bypass joint supply chains and send demands for spare parts to home bases and parent units.⁴

Land forces depend on joint logistic support arrangements for sustainment. Offshore land operations compete for logistic support with each service's collective training system and base-to-base supply requirements. CJLOG commands business units around Australia, but depends on force assignment of deployable logistic assets combined with contractor support to manage supply chains.

Director General Support at HQ JOC and Director General Supply Chain Management at HQ JLC in Melbourne coordinate, but do not control, the deployment of service and commercial assets and capacity and subsequent resupply. Director General Support, Director General Supply Chain Management and Director General Defence Support Operations at DSG do not have habitual relationships or protocols for the sustainment of specific land force preparation.

Applying Lessons

There has been no independent mechanism or model for analysing or auditing operational performance and applying lessons from post-Cold War operations beyond distributing obligatory post-operation reports prepared by headquarters in the chain of command that conducted those operations. The ADF Activity Analysis Database System (ADFAADS) contains lesson descriptions without contextual information to guide operational planners.

⁴ This was the practice in late 2007 in the Middle East Area of Operations. See draft report, Colonel R.J. Breen, 'Review of ADF Force Projection', AWM: COL (OA) papers.

In 2010 the VCDF appointed a Deputy Director Operational Evaluation Framework to chair an Operational Evaluation Management Group and manage ADFAADS and the Defence Lessons Roadmap. Army has both CAL and a Lessons Board at HQ FORCOMD to ensure the capture of operational lessons learnt.

Organisational ‘Muscle Groups’ for Force Projection

A useful means of discussing the impact of the Adaptive Army initiative on the functions of force projection is to group functions into organisational ‘muscle groups’. This analogy demonstrates the need for strong relationships, synchronisation of effort and alignment of responsibility, accountability, authority and resources (see Figure 20).

Improvements

By July 2009, the Adaptive Army initiative had streamlined and strengthened the ADF’s preparatory ‘muscle group’ for land force projection. Lieutenant General Gillespie had removed an operational layer of command and aligned strategic guidance with a commander and headquarters with responsibility, accountability, authority and resources for both preparing assigned land forces for deployment and shaping joint plans in order to maximise the effectiveness and efficiency of land force participation in joint, combined and inter-agency operations. This arrangement facilitated more effective use of warning time and increased the speed of projection of land forces for short-notice deployments.

The separation of the generic and specific force preparation functions under COMD FORCOMD and COMD 1st Division treated specific force preparation as a preliminary operation that was connected from the beginning with strategic guidance and operational-level planning. This relationship between a land force headquarters responsible for both specific force preparation and providing deployable JTF HQ created a habitual and strong relationship that facilitated the effective and efficient preparation of land forces and their positioning for deployment.

The streamlining of specific force preparation was supported by unity of command over generic force preparation. COMD FORCOMD and his staff now controlled standardisation, evaluation, accountability and resource management for all Army training. In particular, the aggregation of the individual and collective training systems under one commander and headquarters strengthened relationships and shared understandings between those who trained individuals and small groups in training establishments and those who trained and prepared forces for operations in units. The development of an individual and collective training continuum (the ATC) synchronised and significantly strengthened the preparatory ‘muscle group’ and allowed more flexibility and responsiveness in the allocation of resources under one commander.

Focusing COMD 1st Division, who commanded a capable headquarters and enabling organisations, on specific force preparation and linking him and his staff directly to CJOPS and HQ JOC for operational-level planning and technical command of deployed land forces considerably strengthened the responsiveness of land forces to short-notice deployments and enhanced the thoroughness of their pre-deployment reconnaissance, administration and training as well as the application of lessons. By 2011 the Army had a force generation structure and system that was more agile, accountable and efficient.

Specific force preparation begins with a gap analysis and a number of transactions before handover of assigned land forces to CJOPS and HQ JOC for deployment, sustainment and joint employment. While minimal in some cases, there are always gaps between the preparedness of land forces and the operational requirements specified by CJOPS and his headquarters for both imminent and enduring, but continuously evolving operations.

Figure 20 – ADF Organisational Muscle Groups for Force Projection

Muscle Group	Functions
<p>Preparatory Army Headquarters, in conjunction with HQ FORCOMD, is responsible for modernisation, sustainability, learning and applying lessons (long and medium term), preparedness (CAPD), contingencies and force assignment. HQ FORCOMD is responsible for individual and collective training systems, readiness and operational tasks for training. HQ 1st Division is responsible for: operational planning and tasking of assigned forces in conjunction with HQ JOC; acquisition, storage, issue and reissue of special-to-mission clothing and personal equipment, as well as special-to-mission leading-edge technology; reinforcement and logistic 'top up' for specific force preparation; reconnaissance; surge of goods and services for mounting operations in conjunction with DSG and JLC; establishment of deployable HQ; handover/takeover of force elements (HQ 1st Division transfers assigned forces that have achieved agreed Start States at Agreed Points to HQ JOC (new operation) and HQ FORCOM (rotation); and learning and applying lessons (short term)</p>	<p>Generic and specific force preparation and rotation, including:</p> <ul style="list-style-type: none"> • modernisation; • sustainability; • learning and applying lessons; • preparedness; • operational tasks for training; individual and collective training systems; • contingencies; • readiness; • force assignment; • operational planning and tasking of assigned forces • acquisition, storage, issue and reissue of special-to-mission clothing and personal equipment, as well as special-to-mission leading-edge technology; • establishment of deployable HQ; • reinforcement and logistic 'top-up'; • reconnaissance; • surge of goods and services; and • handover/takeover of force elements
<p>Projection JMOVGP organizes military and commercial assets (sea, air, land) and coordinates move of personnel and matériel of assigned forces to Agreed Points. HQ JOC is responsible for: Operational command (HQ 1st Division has technical command over deployed land forces); staging and In-theatre RSO&I; prosecuting lines of operation; applying force protection measures.</p>	<p>Deployment, Employment, Command and Protection including:</p> <ul style="list-style-type: none"> • concentration of force elements and matériel; • loading; strategic maritime and air lift; • staging; • In-theatre RSO&I; • executing command and control; • prosecuting lines of operation; and • applying force protection measures.
<p>Sustainment organizations JLC, in conjunction with HQ FORCOM, is responsible for reinforcement and logistic top-up for generic force preparation (to agreed Start State) of assigned forces before transfer to HQ 1st Division at Agreed Points. JLC, in conjunction with HQ 1st Division, is responsible for reinforcement and logistic top-up (to agreed Start State) for specific force preparation before transfer to HQ JOC at Agreed Points. DSG, in conjunction with HQ 1st Division, is the enabling organisation for the surge of goods and services for specific force preparation. JLC, in conjunction with HQ JOC, is responsible for setting up and managing supply chains to deployed JTF. JLC is responsible for planning and executing the logistic support for land forces returning to Australia and reconstituting to agreed levels of preparedness.</p>	<p>Planning, set-up and sustainment of :</p> <ul style="list-style-type: none"> • Preparatory muscle group (surge of goods and services); • Projection muscle group (supply chain management); and • Return and Reconstitution muscle group (clean, load, unload, reinforce and restock).
<p>Return and Reconstitution organizations JMOVGP, in conjunction with HQ JOC and JTF, is responsible for coordinating movement from areas of operation to home bases HQJOC is responsible, in conjunction with JLC, for redeployment and achievement of agreed Start States at Agreed Points for handover to HQ 1st Division. This responsibility includes concentration of force elements and materiel, and cleaning and loading in staging areas. HQ 1st Division, in conjunction with JLC, is responsible for achievement of agreed Start States at Agreed Points for handover to HQ FORCOM. HQ FORCOM, in conjunction with JLC, is responsible for reconstitution of land forces after operations to preparedness and readiness specified by CA (CAPD).</p>	<p>Redeployment and Reconstitution including:</p> <ul style="list-style-type: none"> • concentration of force elements and matériel; • cleaning and loading; • strategic maritime and air lift; • staging; • handover/takeover; and • return to preparedness and readiness levels.

Lieutenant General Gillespie and Major General Morrison had developed several useful concepts to bring order to what had been *ad hoc* and occasionally chaotic pre-deployment preparation of land forces. Start states (level of preparedness of deploying forces) and agreed points (place and time for handover to CJOPS and HQ JOC of prepared land forces), and the levels and standards specified in the evolving training continuum, would clarify what had to be done and how it would be done, as well as the levels of preparedness and readiness to be achieved. Morrison's force generation cycle introduced more order to the rotation function.

The integration of the training continuum and the force generation cycle using specified training levels and standards and progressive assessment also significantly increased the rigour of land forces' preparation for operations. The focus was now on delivering forces that were ready for employment [Ready], reconstituted after employment [Reset] and which maintained their enduring Foundation Warfighting skills [Readying]. The accountability and competency-based nature of the individual training system strengthened the collective training system. The training continuum moved the emphasis from training processes to specific and measurable individual and collective learning and proficiency outcomes.

New concepts had shaped the Army's training system. The first was the focus on Foundation Warfighting skills to align Army training to the five lines of operation contained in the Future Land Operations Concept in general and Adaptive Campaigning in particular. The second and third concepts were the Human Dimension and the Adaptation Cycle, while the contemporary operating environment and the Army's Continuing Learning Process (particularly knowledge management, learning and assessment) comprised the final concepts, setting the context and method for training and synchronising all concepts with their most relevant operational settings and decision-making circumstances.

Given that it is impossible for the Army training system to deliver training for every operational contingency, a mechanism for rapid training needs analysis and the design and development of pre-deployment training was essential. The Land Combat Readiness Centre had to rapidly acquire sufficient knowledge concerning a new area of operations, including its human dimension, lessons and threat groups, from HQ JOC and other sources and translate that knowledge into efficient and effective pre-deployment training and rehearsal programs. COMD FORCOMD could now summon significant training development resources on behalf of COMD 1st Division to both design and develop special-to-mission training and deliver programs to a high standard.

Essentially, the Adaptive Army initiative understood ADF remediation of historical and systemic weaknesses in Australian military force projection and grouped the right organisations with the right structures, responsibilities, accountabilities, authority and resources.

Continuing Challenges

COMD FORCOMD will continue to be challenged by the need to balance the requirements to train for 'the war' (Foundation Warfighting), 'a war' (enduring operations) and 'the next war' (contingencies) in order to minimise the gap between the readiness of land forces and the requirements of CJOPS and HQ JOC. It will be crucial for staff groups at HQ FORCOMD and HQ 1st Division to quickly identify readiness gaps and arrange personnel and logistic 'top-up', as well as custom-designed, developed and delivered special-to-mission training and administration. This is the crucial support and supported relationship between FORCOMD and HQ 1st Division that will depend on timely information and collaboration if it is to succeed.

HQ FORCOMD staff will also face the challenges of keeping abreast of regional and international developments and the operational requirements of deployed land forces in order to continuously improve Foundation Warfighting training and maximise its contemporary relevance.

Adaptive Army improvements will have limited impact unless they are connected and synchronised with the ADF's joint projection and sustainment 'muscle groups'. Both COMD FORCOMD and COMD 1st Division depend on those who control joint movements, joint logistics and contracted base support for the smooth operation of these new Adaptive Army arrangements.

While COMD FORCOMD commands the Army's deployable logistic assets (17 CSS Brigade), he and his staff have no direct links or contingency protocols with either CJLOG or HQ JLC (Director General Supply Chain Management), or CJOPS and HQ JOC (Director General Support). The challenge in planning logistic support and supplying land forces offshore will be to maintain a habitual and close relationship between 17 CSS Brigade – which has the resources – and CJLOG and Director General Support at HQ JOC – who have the authority, responsibility and accountability for sustainment of operations, but no resources until the CDF assigns them elements from 17 CSS Brigade.

In 2011 there was no agreed joint doctrine for logistic support to specific force preparation. Draft doctrine was obsolete. It did not reflect the capabilities and capacities of Defence organisations and civilian infrastructure, nor lessons from past operational experience. There was a lack of clarity in how to plan and conduct pre-deployment operations, and in planning and establishing supply chains.

The concentration of assigned forces, contingents and individuals in mounting bases (ports, barracks and air bases) and their subsequent pre-deployment preparation had been ad hoc and poorly coordinated in the past. In 2011 there did not appear to be agreed or rehearsed arrangements between HQ JOC, JLC, DMO or DSG for surges required for the pre-deployment supply of stocks or garrison services to deploying land forces and the establishment of supply chains.

It was unclear when and where CJOPS and HQ JOC should assume responsibility for deployment, employment and sustainment of assigned forces following specific force preparation and once COMD 1st Division had certified land forces and contingents as ready for employment.

The responsibility, accountability, authority and resources for staging land forces during deployment and in-theatre RSO&I following arrival remained unclear. RSO&I is the transition from deployment to employment, both for new operations and subsequently for rotations for enduring operations.

The period between the arrival of land forces in theatre and operational employment represents a highly vulnerable point. Deploying forces may not be capable of self-sustainment or self-protection. A number of unanswered questions remain which relate to this period of vulnerability. These include: what is the agreed point from deployment to employment? Will the agreed point between HQ 1st Division and HQ JOC prior to deployment always be in Australia? In certain circumstances, could deployment, staging and RSO&I form part of the process for preparing forces for employment? What are the planning and implementation implications of locating the agreed point *after* deployment?

The Way Ahead – Synchronisation of the 'Muscle Groups'

The Adaptive Army initiative has strengthened the preparatory 'muscle group' in support of the projection of land forces – but only land forces. The ADF's joint command and control arrangements and the creation of joint logistic and civilianised garrison support arrangements have consolidated the ADF's projection and sustainment 'muscle groups', but not necessarily synchronised them. Inter-agency synchronisation between the preparatory and sustainment 'muscle groups' also remains problematic. Aside from the obvious importance of the relationship between HQ FORCOMD and HQ 1st Division, specific force preparation depends on the establishment of a relationship between HQ 1st Division and Director General Support at HQ JOC, and between JLC and DSG that is habitual and close. In 2011 these relationships were not in place.

The Adaptive Army initiative has strengthened what the Chief of Army can do to bolster the generic preparedness of land forces for joint employment – but this will be for nought if joint arrangements for sustainment and transportation by sea and air are not slick. The task of strengthening the ADF's joint sustainment 'muscle group' and projection group, and aligning these with the Army's pre-deployment preparations now falls to others. This reorganisation of the Army is not just an isolated event, simply another milestone change similar to the establishment of the functional command system in the 1970s. The Army has transformed itself into an adaptable military force focused on anticipating the future and applying short, medium and longer term learning loops that stimulate continual adaptation and improvement. However, the benefits will be negated if the Army's adaptation cycle is not aligned with those of the other services as well as the wider Defence organisation.

The synchronisation of the joint and contracted preparatory and projection 'muscle groups' with the sustainment 'muscle group' suggests that the time has come to institute an 'Adaptive Defence' initiative. The challenge will be to implement a scoping and consultation process that brings key stakeholders together to examine problems with the status quo and to develop options for organisational change. The 4D workshop process not only brought operational experience and intellect to bear, it also distributed ownership of change – keys to successful and enduring reorganisation.

The VCDF is the logical sponsor for the 'Adaptive Defence' initiative as he is responsible to the CDF for the conduct of operations and their sustainment in conjunction with CJOPS and CJLOG respectively. Hopefully, this publication will alert him and the Chiefs of Navy and Air Force to this opportunity for strengthening Australia's defence of its sovereignty, as well as the protection of national interests further afield.

Bibliography

Australian Commonwealth government publications

Department of Defence,

—, *2013 Defence White Paper*, Department of Defence, Australian government, Canberra, 2013.

—, *Defending Australia in the Asia Pacific Century: Force 2030*, Department of Defence, Australian government, Canberra, 2009.

—, *Defence Capability Development Manual*, Australian government, Canberra, 2006.

—, *Joint Warfighting in the 21st Century*, Defence Headquarters, Canberra, 2008.

—, *Joint Operations for the 21st Century*, Defence Headquarters, Canberra, 2007.

—, *The Defence of Australia 1987*, AGPS, Canberra, 1987.

Australian Army, Directorate of Combat Development, *Army Continuous Modernisation Process Handbook*, Defence Publishing Service, Canberra, 2008.

—, Head Modernisation and Strategic Planning – *Adaptive Campaigning, Army's Future Land Operating Concept*, Army Headquarters, Canberra, 2009.

—, 'Report of the Army Review Committee in 1970, the Command and Organisational Structure of the Army in Australia', 1971.

Australian Defence Force, *Joint Warfighting*, Capstone Series, Australian Defence Force Doctrine Publication ADDP-D-4, Defence Publishing Service, Canberra, 2004.

Other government publications

US Training and Doctrine Command, Pamphlet 525-3-7, *The US Army Concept for the Human Dimension in Full Spectrum Operations 2015-2024*, US Department of Defense, 2008

—, Pamphlet 525-3-7-01, *The US Army Study of the Human Dimension in the Future 2015-2024*, US Department of Defense, 2008.

—, Pamphlet 525-5-500, *The US Army Commander's Appreciation and Campaign Design*, US Department of Defense, 2008.

US Armed Forces, 'Commander's Handbook for an Effects-Based Approach to Joint Operations', US Joint Forces Command, 2006.

Unpublished Commonwealth Government Records

Australian War Memorial

COL (OA) papers (contained in closed collection 'Papers of the Official Historian of Australian Peacekeeping, Humanitarian and Post –Cold War Operations').

Interviews and private communications

Ranks are those held at the time of the interview.

Bilton, Colonel Greg, interview with author, Command and Staff College, Weston ACT, 6 December 2009.

Caughey, Brigadier S.F., interview with author, Victoria Barracks, Sydney, 15 July 2010.

Fegan, Lieutenant Colonel K., interview with author, Enoggera Barracks, Brisbane, 5 August 2010.

Frewen, Brigadier J.J., interview with author, Victoria Barracks, Sydney, 3 December 2010.

Morrison, Major General D.L., interview with author, Victoria Barracks, Sydney, 3 December 2009.

Ryan, Lieutenant Colonel M., annotations on penultimate draft, 30 August 2010.

Sengelman, Brigadier J., interview with author, Victoria Barracks, Sydney, 29 July 2010.

Slater, Major General M.D., interview with author, Enoggera Barracks, Brisbane, 5 August 2010.

Symon, Major General P.B., interview with author, Army Headquarters, Canberra, 22 April 2010.

—, e-mail to the author, 23 April 2010.

Wilkie, Brigadier S., interview with author, Victoria Barracks, Sydney, 15 July 2010.

Books

Breen, Bob, *A Little Bit of Hope: Australian Force Somalia*, Allen & Unwin, Sydney, 1998.

—, *Giving Peace a Chance: Operation Lagoon, Bougainville 1994: A Case of Military Action and Diplomacy*, Strategic and Defence Studies Centre, Australian National University, Canberra, 2001.

—, *Mission Accomplished: The Australian Defence Force Participation in the International Forces East Timor (INTERFET)*, Allen & Unwin, Sydney, 2000.

—, *Struggling for Self Reliance: Four Case Studies of Australian Regional Force Projection in the Late 1980s and the 1990s*, ANU ePress, Canberra, 2008.

Bryant, Jim, *A More Lasting Peace: Reflections on Interagency Operations in the Solomons and Iraq*, Land Warfare Studies Centre, Canberra, 2007.

Holland, John H., *Hidden Order: How Adaptation Builds Complexity*, Addison-Wesley Publication Company, New York, 1995.

Horner, David (ed.), *Duty First: The Royal Australian Regiment in War and Peace* (2nd edn), Allen & Unwin, Sydney, 2008.

—, *The Australian Centenary History of Defence*, Vol. 4, *Making the Australian Defence Force*, Oxford University Press, Melbourne, 2001.

Lowry, Robert, *The Last Knight: A Biography of General Sir Phillip Bennett AC, KBE, DSO*, Big Sky Publishing, Newport, 2011.

Nye, Joseph, *Soft Power: The Means to Success in World Politics*, Public Affairs Books, New York, 2004.

—, *The Paradox of American Power: Why the World's Only Superpower Can't Go It Alone*, Oxford University Press, New York, 2002.

—, *Understanding International Conflicts: An Introduction to Theory and History* (7th edn), Longman Classics in Political Science, New York, 2009.

Palazzo, Albert, *The Australian Army: A History of its Organisation, 1901-2001*, Oxford University Press, Melbourne, 2001.

Smith, Rupert, *The Utility of Force: The Art of War in the Modern World*, Penguin Books Ltd, London, 2005.

Chapters and Articles

Horner, David, 'The Higher Command Structure for Joint ADF Operations' in Ron Huisken and Meredith Thatcher (eds), *History as Policy: Framing the Debate on the Future of Australia's Defence Policy*, Canberra Papers on Strategy and Defence No. 167, Strategic and Defence Studies Centre, ANU, 2007.

Morrison, Major General D.L., 'Forces Command', *United Service*, Vol. 61, No. 4, summer 2010.

Papers

Grisogono, A. and Ryan, A., 'Designing Complex Adaptive Systems for Defence', Land Operations Division, DSTO, 2005.

—, 'C2 Concepts, Theory and Policy, Networks and Networking', Command and Control Research and Technology Symposium, 'Adapting C2 to the 21st Century: Operationalising Adaptive Campaigning', 2007.

Index

A

- ab initio training x
- administrative control x
- agreed point x, 59, 76
- Alexander, Colonel 23
- Alexander, Major General Paul 30
- amalgamating LHQ and HQ training command 69–70
 - process 72–3
- applying lessons 91–2
- army training continuum x
 - designing 42–3
 - inputs to 43–5
 - levels of training 50, 84
 - structure 45
 - training standards 51
- articulating and directing change 33–6
- assessment 51
- audit of the initiative 89–96
 - steps 89

B

- Baker, General John 11
- Bartels, Brigadier Nick 23
- Bilton, Colonel Greg 14–15, 18, 31
- Black Hawk helicopter disaster 24
- Blamey, General Sir Thomas 80
- Bornholt, Brigadier Mark 19
- Bottrell, Colonel 23
- Brennan, Dr Mike 23
- Brewer, Colonel Mark 19, 23, 69
- Burns, Colonel James xiv, 86

C

Caligari, Major General John 22, 80–1, 85
Cantwell, Major General John 30
Caughey, Brigadier Shane xiv, 36, 69–72, 79
Cavenagh, Major General Grant 33, 62, 64–5, 67–8
certification of standards 76, 84
chronology xiii–xv
Clay, Brigadier Peter 69, 77–8
collective training x
contemporary operating environment 45–7
continuing challenges 94–5
Cook, Brigadier Bruce 19, 23
Corbett, Sir Julian Stafford 1–2
Cosgrove, General Peter 90
Cosson, Major General Elizabeth 62, 64–5, 68
Crane, Major General Mike 30
Creagh, Brigadier David 19, 22–3, 66–8, 86
Cruickshank, Iain 78
Culley, Adam 28

D

deployment and in-theatre training 49
direct command units
 tasking relationships 74
division of responsibilities and command arrangements 55–6
Dunstan, Lieutenant General Don 17

E

effects-based structures 47
Evans, Colonel Jim xiv, 86
Evans, Lieutenant General Mark 28, 33, 51, 54, 62, 65, 67–8
Evans, Colonel Paddy 19, 23
Exercise Hamel 2010 80–8
 conduct of 86
 designing 83
 outcomes 86–8

The Road to Hamel 82–3

experimentation and experiential learning 85

F

Fairweather, Major General Mike 30

Fegan, Lieutenant Colonel Kahlil 78

Field, Colonel Chris 19, 23

Fitzgibbon, Joel 18, 35

Fleming, Cherylne 19

Fogarty, Brigadier Gerard 19, 22

force generation x

- cycle 48–9, 58

- rotation of land forces 58

force preparation x

force projection

- functions of 5–6, 20

- land, on see land force projection

- organisational ‘muscle groups’ for 92–3

- proficiency 6–7

Forces Command (FORCOMD)

- division of responsibilities with HQ 1st Division 56

- options for 21

- tasks for 39

- the way ahead 78–9

foundation warfighting training x–xi

Frewen, Brigadier John xiv, 82–5, 88

G

Generals’ day 30

generic force preparation 37–53

genesis of initiative 13–32

Gillespie, Lieutenant General Ken xiii–xiv, 3, 11, 13–14, 18, 22, 24, 28, 30–6, 38, 40, 42–3, 45, 51–3, 55–6, 59–60, 62, 68, 70, 73, 75–6, 79–80, 86, 92, 94

Gilmore, Brigadier Gus 19

Graham, Lieutenant Colonel David 85

Grisogono, Dr Anne-Marie 19

Gunder, Colonel Ash 77–8

H

Hassett, Major General Frank 12, 16–17, 69, 89

HQ 1st Division

- division of responsibilities with Forces Command 56

- retasking 76–7

- the way ahead 78

Headquarters Forces Command (HQ FORCOMD)

- designing 37–41

- detailed organisation 41

- outline organisation 41

- testing the structure 71–2

Hicks, Colonel 23

Higgins, Brigadier Don 19, 22

high readiness forces x

Hindmarsh, Major General Mike 42, 75

Horrocks, Brigadier Bill 64–5, 67

Houston, Air Chief Marshal Angus 11, 14, 18, 35, 43, 54–5, 64

Hurley, Lieutenant General David 40, 62, 65, 68

I

implementing change 69–79

improvements from initiative 92–4

individual training x

international engagement and joint exercises 50

J

joint command and control, reform of 90

K

Kelly, Major General Mark xiii, 30, 36–7, 55

L

land combat readiness centre and 39 PSB 77

land force projection 4–5, 7, 48

- problems with 8–10

- remediation of historical problems 89–92

Laurie, Lieutenant Colonel 23

Leahy, Lieutenant General Peter 3, 13–14, 17

learning lessons 52

learning loops 52

Lewis, Simon 62, 68

logistic support process 65

Luhrs, Colonel David 23

M

McIntyre, Colonel Max 82, 87

McOwan, Major General Tim 30

McNam, Major General Maurie 30

Maier, Air Commodore Michael 68

Mahy, Colonel Michael 23

Miko, Captain 23

mission-specific training xi

model, choice of 18–19

Monash, Lieutenant General John 78

Moon, Brigadier Mick 19, 22–3, 29, 36, 70

Morrison, Lieutenant General David xiii–xiv, 2–3, 11, 13–14, 18–19, 22–4, 29–31, 35–6, 42–3, 45–51, 53, 55, 58–9, 62–3, 65–72, 74–6, 78–85, 87–8, 94

mounting authority 76

mounting headquarters 76

'muscle groups' for force projection 92–3

 synchronisation of 95–6

O

O'Leary, Lieutenant Colonel Shaun 23, 71

operations workshop 19–22

 back brief 22

 Model 1 20

 Model 2 24

P

past structural reform 16–18

performance gaps, closing 84–5

Perot, Colonel Ross 69, 77

personnel management and logistic support workshop 23–4

Model 1 25

Model 2 25

Power, Major General Ash xiii, 22, 30, 36–8, 40, 42–3, 55, 70–2, 75, 79
preparing to deploy and establishing supply 63–8

R

reconnaissance and deployment 91

reconstitution xi

Red Team review 29

rehearsal, lack of 90

reorganising the army, reasons for 10–12

Rerden, Brigadier Mal 19, 23

resource management and governance workshop 24–7

Model 1 26

Model 2 26

response to Adaptive Army initiative 66

rotation of land forces 58

Ryan, Lieutenant Colonel Mick 14–16, 18–20, 22–3, 27, 29, 31, 35

S

Sanderson, Lieutenant General John 80

Saul, Brigadier David 23, 36, 64–6

secret planning 14–16

Sengelman, Brigadier Jeff xiv, 36, 69–70, 74–5, 79–81

17 CSS Brigade, role of 66

Shanahan, Lieutenant Colonel John 71

Short, Colonel Peter 19, 72

short learning loop, maintaining 78

Simpson, Brigadier Jim 19, 23

Sims, Brigadier Andy 64–8

6th Brigade

building 75–6

formation 73–5

Slater, Major General Mick xiv, 12, 14, 30, 36, 42, 55, 62–3, 66–9, 76–81, 83–4

Smith, Lieutenant Colonel Clark 23, 77

specific force preparation 54–62

- concept 56–8
- development tasks 56
- organisational responsibilities 57

start state xi, 60

surges xi, 60

sustainment

- command and control of 64–5
- disconnections in 91
- planning, marrying up 67

Sutton, Colonel Lester 23

Symon, Major General Paul xiii, 11, 14–16, 18–19, 22–4, 27–31, 35–6, 55, 62, 69, 80–1

T

technical control xi

Thomas, Commodore Clint 64–5, 67–8

time constraints 90

Tracey, Major General the Honourable Justice R.R.S 30

training

- 'a war' and 'the war', for 59
- ab initio training x
- collective training x
- foundation warfighting training x–xi
- individual training x
- mission-specific training xi
- priorities, levels, standards, evaluation and certification 50–1

transfer of responsibilities 42

Tucker, Colonel Mike 18–19, 22–3, 27, 31

V

Victoria Barracks, reorganisation at 70–1

W

Walk, Lieutenant Colonel 23

war

- 'a war' xi
- 'a war' and 'the war', training for 59
- problems with being prepared for 'a war' 81–2

'the next war' xii

'the war' xii

ways and means, command of 91

White, Professor Hugh 1–2

Wilkie, Brigadier Simone xiv, 36, 69–72, 79

Williams, Major General Craig 71

Wilson, Major General Richard xiv, 30, 36, 42, 55–9, 61

Workshop 1 - Operations 19–22

back brief 22

Model 1 20

Model 2 24

Workshop 2 - Personnel Management and Logistic Support 23–4

Model 1 25

Model 2 25

Workshop 3 - Resource Management and Governance 24–7

Model 1 26

Model 2 26

About the Author

Associate Professor Robert (Bob) Breen is the Director of Deakin University Post-Graduate Courses and the Academic Advisor at the Centre for Defence and Strategic Studies, Australian Defence College, Weston Creek, Canberra.

Professor Breen was previously a research fellow at the Strategic and Defence Studies Centre, Australian National University. While there he completed Volume V of the *Official History of Australian Peacekeeping, Humanitarian and post-Cold War Operations*, 'Australia as a "Good Neighbour": Supporting Peace in the South Pacific 1980–2006' which is awaiting departmental clearance prior to publication.

He has published several books and monographs on Australian post-Cold War operations. Following periodic field research during ADF operations in Somalia, Rwanda, the Middle East, Mozambique, Bougainville, East Timor and Afghanistan, Professor Breen published *A Little Bit of Hope: Australian Force–Somalia*, and *Mission Accomplished: Australian Defence Force participation in the International Force–East Timor*. His most recent book, *Struggling for Self-Reliance: Four case studies of Australian regional force projection in the late 1980s and the 1990s* is based on his PhD thesis.